



CONNECTING THE FUTURE



Home | Hotel | Office



CONNECTING THE FUTURE



# Modular Power + Connect Sustainable





Mukesh Panjwani | CEO

"The future is a canvas awaiting the strokes of those who believe in the beauty of their dreams". At MX MDR Technologies Ltd, we embody this ethos with our unwavering commitment to connecting the future. As the torchbearer of excellence, MX, which emanates from the magic of Xcellence, was founded in 1978 by the visionary entrepreneur, Mr. Mukesh V Panjwani. Pioneering the industry, MX stands as the leading manufacturer of Electronics, Audio Video cables and Electrical accessories. Our state-of-the-art manufacturing unit is nestled in Vasai, Dist. Palghar, Maharashtra, while our dynamic Experience center is based in Mumbai, Bengaluru, Hyderabad, Delhi & Pune, India.

Since inception, MX has consistently delivered tailored electrical and electronic solutions to Architects, Interior Designers, Furniture Manufacturers, System Integrators, Electrical Contractors, Service Providers, and Corporate Clients. Our strong distributor network spans across India, while our global footprint extends to Israel, Spain, Italy, France, the Netherlands, the UAE, Saudi Arabia, South Africa, and other international markets.

Carrying the spirit of "Made in Bharat" to the world, MX is not just a brand — it is a legacy of trust, credibility, and sustained value creation.

## Our Principles:

- SERVICE
- QUALITY
- DESIGN
- INNOVATION
- MADE IN BHARAT

In 2016, MX Power emerged as a dedicated vertical, strengthening our portfolio with advanced electrical power and cable management systems. Designed for Residential, Industrial, Institutional, Hospitality, and Healthcare segments, MX Power reflects our relentless pursuit of progress and innovation.

## AWARDED MOST INNOVATIVE PRODUCT BY ORGATEC, GERMANY



# About Us



BIS CERTIFIED



ISI CERTIFIED  
CM/L: 7700219316

IT power distribution

HOME

**48** years of experience

in developing, manufacturing and distributing high-quality power distribution solutions, AV accessories & pro audio products

connecting the **future**

over **10000** standard products



BASED IN

MUMBAI

HOTEL

**1978**  
Year founded



WORLDWIDE

MX **POWER**

POWER DISTRIBUTION UNITS

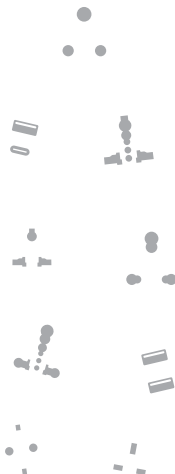

PROVIDING **LIFE** QUALITY

AROUND **200** EMPLOYEES WORLDWIDE

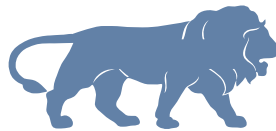

MADE IN **BHARAT**



OFFICE

# Contents

NUEVO MODULAR POWER TRACKS C55 / C34	8-11
STANDARD POWER TRACKS	12-13
ADAPTORS & MULTIMEDIA CONNECTORS	14-15
NUEVO UNDER DESK POWER & DATA TRACKS S68	16-17
NUEVO DESKTOP POWER & DATA TRACKS D88	18-19
FREE STANDING TOWER TRACKS/POWER POLE	20-23
VERTICAL POWER & DATA POLE FLOOR TO CEILING	24-25
DESKTOP CONSOLE	26-29
UNDER DESK CONSOLE	30-33
IN-SURFACE POWER DISTRIBUTION UNIT C55 / C34	34-37
EMBEDDED POWER & DATA SOCKET - SCREW & PUSH TYPE	38-41
POWER CUBBY	42-49
DESKTOP POWER GROMMET	50-53
PLUTO DOCK & GROMMET	54-57
POWER POST PUSH-UP	58-62
SOLO POWER MANAGER/FURNITURE NESTED POWER	63-65
FLIP TOP PUSH	66-67
AERO FLIP	68-69
COMFORT TURN POP-UP	70-71
DUPLEX ACCESS FLAP	72-73
CABLE CUBBY & CABLE RETRACTOR	74-77
CABLE WING	78-79
DOCKSQUARE	80-81
DESKTOP MOTORIZED & MANUAL TURN POP-UP	82-83
ACCESS FLAPS	84-86
CABLE ORGANISER	87
COMPACT NETWORK PDU WITH SWITCHABLE C13 OUTLETS	88-99
VERSATILE POWER DRISTRIBUTION UNIT (PDU)	90-91
TRANSPARENT PROTECTIVE WINDOW COVER FOR MCB	92
IP66 WATER PROOF SOCKET BOX	93-94
45mm x 45mm POWER & DATA CUBBY MODULE BOX	95
CEILLING MOUNT POWER BOX	96-97
FLOOR BOX	98-107
45mm x 45mm SOCKET PLATES	108-113
RETRACTABLE & PORTABLE CABLE REELS	114-116
CORDS & POWER EXTENSIONS	117
INDUSTRIAL PLUGS & SOCKET	118-131
SMART INTELLIGENT POWER DISTRIBUTION UNIT(PDU)	132

# Research & Development

## 1. Safety and Efficiency :

- Developing fire-resistant materials for outlet housings.
- Designing outlets with improved electrical conductivity for reduced energy loss.
- Integrating surge protection technology to safeguard against electrical damage.
- Implementing overload protection mechanisms to prevent overheating.
- Exploring new materials and manufacturing techniques to improve durability and longevity.

## 2. Sustainability and Environmental Impact :

- Developing energy-efficient outlets that consume less power when not in use.
- Exploring the use of renewable energy sources to power manufacturing processes.
- Reducing waste and minimizing the environmental impact of production.

## 3. User Experience and Innovation :

- Designing outlets with improved usability and accessibility features.
- Exploring new functionalities like USB charging ports and Quick Charge Technologies.
- Creating aesthetically pleasing outlet designs that complement modern home décor.
- Enhancing user convenience through features like tamper resistance and childproof protection.

## 4. Indian Regulatory Compliance and International Standards :

- Ensuring all MX power outlets comply with relevant national and international safety standards.
- Investing in testing and certification to guarantee product reliability and safety.
- Continuously staying updated on regulatory changes and adapting product designs accordingly.



# Product Innovations

## Multiple Socket:

MX revolutionizes power outlets with innovative Multi-Nation Sockets, including Indian, Universal, and UK variants. Our cutting-edge designs enhance compatibility and convenience, ensuring seamless connectivity for global users. Experience the future of power solutions & wireless charging.



## Multi colors :

Our multi-colored and customizable power outlets are more than just functional tools; they are design statements. By embracing this innovation, you can transform your workspace into a vibrant and inspiring environment that reflects your unique personality and brand.



## Quick & Wireless Charging :

We unveil our groundbreaking innovation by seamlessly integrating Qualcomm Quick Charge 3.0 for Power Delivery (PD) charging directly into our power outlets. Elevate your charging experience with MX's state-of-the-art technology, featuring wireless charging options for swift and efficient power delivery to your devices. Experience accelerated charging, thanks to our unwavering commitment to advanced solutions.



## Made In Bharat :

We have played a pivotal role in India's growth through our participation in the "Make in India" initiative. By manufacturing homegrown power outlets, we contribute to the nation's self-reliance goals. These locally-produced outlets adhere to global standards, showcasing our commitment to quality and innovation. This not only boosts the domestic manufacturing sector but also positions us as a key player in India's technological advancement.



# Function Modules

## Childproof product

Our power outlets boast a childproof protection system, rigorously tested to meet international standards. Designed with utmost safety in mind, these outlets ensure a secure environment, adhering to globally recognized benchmarks. Rest assured that our childproof features provide robust protection, guaranteeing a safe and reliable electrical solution for your home.

---



## Surge protection

We take power safety to the next level with built-in surge protection on our power outlets. Safeguard your devices from voltage spikes and surges, ensuring uninterrupted performance and extending the lifespan of your electronics. Trust us for advanced surge protection, providing peace of mind for your connected devices.

---



## EMI/Noise filters with Advanced X3 Mov technology

Our power outlets stand out with EMI/Noise filters and Advanced X3 MOV technology, ensuring a clean and efficient power supply. This innovative combination eliminates electromagnetic interference and unwanted noise, guaranteeing a reliable and stable power source for your devices. Experience optimal performance and protection with our advanced technology.

---



## Circuit Breaker

Redefines safety with our power outlets featuring a built-in circuit breaker switch. This smart addition ensures immediate protection against overloads and short circuits, providing a reliable shield for your devices and peace of mind for users. Experience a new level of safety.





CONNECTING THE FUTURE

## USB Charging

Enhance convenience with built-in USB slots on our power outlets. Charge your devices directly without the need for adapters, providing a seamless and efficient charging solution. With multiple options like USB A 3.0, USB A+ C, and USB C up to 95 watts power. Experience the future of connectivity with us, where power and versatility meet in a single outlet.

---



## Safety Shutter

Safety is paramount with our power outlets featuring innovative safety shutters. These built-in shutters provide an extra layer of protection, preventing accidental contact with live components. We ensure peace of mind, prioritizing safety in every socket for a secure and worry-free power experience.

---



## ISI Certified

Built for safety you can trust. Our power outlets are equipped with ISI Certified sockets, ensuring compliance with rigorous Indian safety and quality standards. Designed for durability, reliable conductivity, and enhanced protection, these sockets deliver consistent performance while prioritizing user safety.

---



## Universal Sockets & UK sockets

Our power outlets feature Universal Socket, offering a versatile solution for global connectivity. This innovative feature accommodates a variety of plug types, including the UK plug, making it convenient for users worldwide. Experience seamless compatibility and enhanced flexibility with Universal Socket – where power meets adaptability



[www.mdrelectronics.com](http://www.mdrelectronics.com)



# Modular Power Tracks

## MX NUEVO C55

### RECESS MOUNT POWER & DATA TRACK

The MX C55 Recess mount modular track series is designed for straightforward recessed mount installation, catering to power, data, and multimedia needs while featuring a cable management compartment. Ideal for applications such as boardrooms, conference rooms, and meeting room tables, it comes highly recommended for office and original equipment manufacturer (OEM) segments in system furniture. Customizable to any plug or multimedia socket configuration, and adjustable to fit specific length requirements.

#### SPECIFICATION

##### Electrical

Rated Voltage : 250V— Single-phase

Rated Current : 32 Amps (Max)

Frequency : 50 / 60Hz

Terminal Capacity : 1.25 mm<sup>2</sup> - 4 mm<sup>2</sup>

##### Size

Standard Length : 400mm-1200mm (refer table)

Customization : Lengths & configuration available upon request

##### Material

Track Housing : Anodized Aluminum

End Cap : Polycarbonate

Busbar Carrier : Polycarbonate

Conductor : Phosphor Bronze (Copper)

Finish: Black, Silver



#### MX Nuevo C55

MX No	Sizes	Dimensions
6301	400mm	75 x 55
6301 A	500mm	75 x 55
6301 B	600mm	75 x 55
6301 C	800mm	75 x 55
6301 D	900mm	75 x 55
6301 E	1000mm	75 x 55
6301 F	1200mm	75 x 55

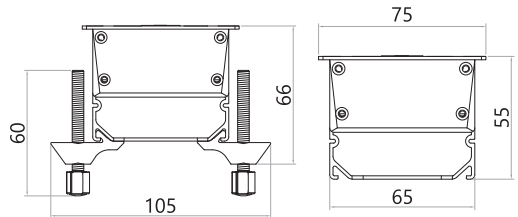

#### Customized Multimedia & Sockets on Request :

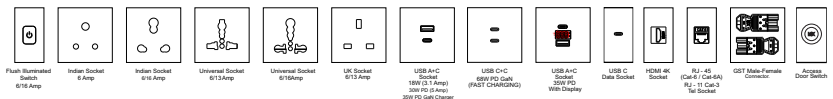



# Modular Power Tracks

## MX NUEVO C34

### RECESS MOUNT COMPACT POWER TRACK

The MX C34 Recess mount modular track series is designed for straightforward recessed mount installation, catering to power, data, and multimedia needs while featuring a cable management compartment. Ideal for applications such as boardrooms, conference rooms, and meeting room tables, it comes highly recommended for office and original equipment manufacturer (OEM) segments in system furniture. Customizable to any plug or multimedia socket configuration, and adjustable to fit specific length requirements.

#### SPECIFICATION

##### Electrical

Rated Voltage : 250V— Single-phase

Rated Current : 32 Amps (Max)

Frequency : 50 / 60Hz

Terminal Capacity : 1.25 mm<sup>2</sup> - 4 mm<sup>2</sup>

##### Size

Standard Length : 400mm-1200mm (refer table)

Customization : Lengths & configuration available upon request

##### Material

Track Housing : Anodized Aluminum

End Cap : Polycarbonate

Busbar Carrier : Polycarbonate

Conductor : Phosphor Bronze (Copper)

Finish: Black, Silver



#### MX Nuevo C34

MX No.	Sizes	Dimensions
6302	400mm	75 x 34
6302 A	500mm	75 x 34
6302 B	600mm	75 x 34
6302 C	800mm	75 x 34
6302 D	900mm	75 x 34
6302 E	1000mm	75 x 34
6302 F	1200mm	75 x 34

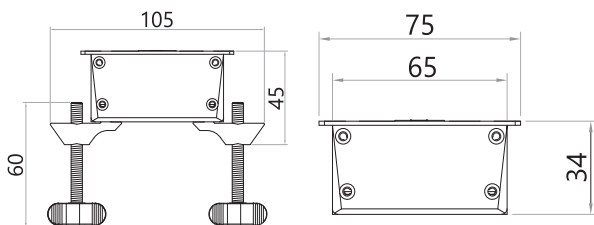

#### Customized Multimedia & Sockets on Request :

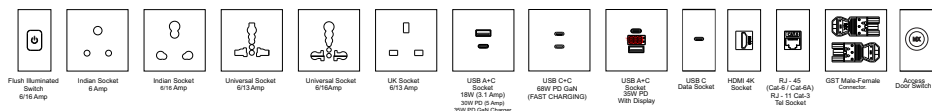



# Standard Power Tracks

We set the standard with on-surface and in-surface tracks, providing a mid-height power solution ideal for office spaces, server rooms, display counters, kitchens, schools, and various shared environments. Engineered for effortless usability, it seamlessly integrates with free tabletop-mounted solutions. MX tracks are customizable, offering voice/data modules such as Cat 6, Cat 6a, Cat 6 shielded, and audio/video modules like HDMI, USB C, USB A 2.0/3.0, VGA, 3.5mm Stereo, Display Ports, USB C Charging and Retractable Modules.

**MX Wall to Wall** in-surface modular track series is the sleek and perfect solution for recessed power & data installations allowing easy access to power for tables, desk, partitions and kitchen dado. Plastically sleek and perfect to go with modular kitchen, living room OEM segment.

## SPECIFICATION

### Electrical

Rated Voltage : 250V— Single-phase  
 Rated Current : 32 Amps maximum  
 Frequency : 50 / 60Hz  
 Terminal Capacity : 1.25 mm<sup>2</sup> - 4 mm<sup>2</sup>

### Material

Track Housing : Anodized Aluminum  
 End Cap : Polycarbonate  
 Busbar Carrier : Polycarbonate  
 Conductor : Phosphor Bronze (Copper)  
 Finish: Black, Silver & Rose Gold

### Size

Standard Length : 400mm-1500mm (refer table)  
 Customization : Lengths & configuration available upon request



MX Surface Mount Track With Switch

MX No.	Sizes	Dimensions
6000	400mm	70 x 25
6000A	600mm	70 x 25
6000B	800mm	70 x 25
6000C	1000mm	70 x 25
6000D	1200mm	70 x 25
6000E	1500mm	70 x 25

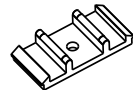
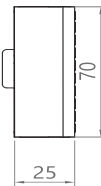

Wall Mount Bracket

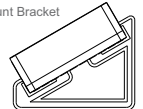
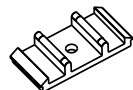
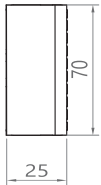

Table Mount Bracket



MX Surface Mount Track Without Switch

MX No.	Sizes	Dimensions
6100	400mm	70 x 25
6100A	600mm	70 x 25
6100B	800mm	70 x 25
6100C	1000mm	70 x 25
6100D	1200mm	70 x 25
6100E	1500mm	70 x 25



Wall Mount Bracket

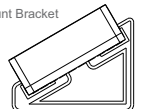
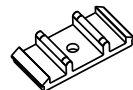
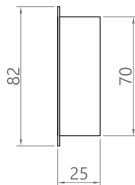

Table Mount Bracket



MX Recess Mount Track

MX No.	Sizes	Cutout (mm)
6200	400mm	390 x 71
6200A	600mm	590 x 71
6200B	800mm	790 x 71
6200C	1000mm	990 x 71
6200D	1200mm	1190 x 71
6200E	1500mm	1490 x 71



Wall Mount Bracket

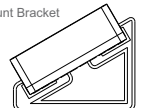
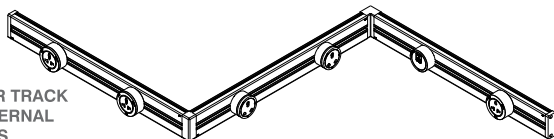

Table Mount Bracket

# Wall to Wall Power Track



WALL TO WALL POWER TRACK WITH INTERNAL & EXTERNAL CORNER CAPS & LINKS

# Premium Series LED Adaptors

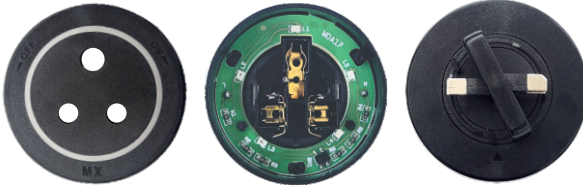

## Triple Safety

The MX Power track is an open circuit that can only be closed with an adaptor which matches up in depth, height and length. while a solid state shield prevents any current leakage.

## High Temperature Flame Retardant FR-PC Material

Adaptor shell apots PC high-efficiency flame retardant casing, preventing accidents



MX 6021  
6 Amperes  
Indian Standard  
BIS Approved



MX 6015  
6/10/13 Amperes  
IN/EU/BS



MX 6016  
6/13 Amperes  
IN/BS



MX 6017  
13 Amperes  
BS



MX 6018  
15 Amperes  
USA-JPN



MX 6012  
MX Classic  
GERMAN SCHUKO  
Socket 16Amps



WiFi  
MX 6022 WIFI  
6/13 Amperes  
IN/EU/BS



WiFi  
MX 6023 WIFI  
6/13 Amperes  
IN/BS



WiFi  
MX 6024 WIFI  
6 Amperes  
Indian Standard



MX 6025  
6/16 Amperes  
Indian Standard  
BIS Approved



MX 6026  
C & A 20 Watts  
USB Charger



MX 6027  
C & A 30 Watts  
USB PD Charger

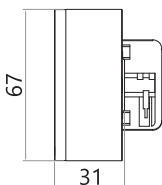

Premium Adaptors  
Blue LED

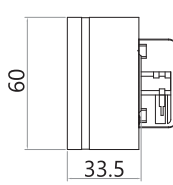

Classic Indian Adaptors  
6/16A

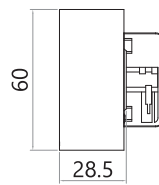

Classic Compact Adaptors

# Classic Series Adaptors

MX 6001  
6/10/13 Amperes  
IN/EU/BS



MX 6002  
6/13 Amperes  
IN/BS



MX 6003  
6/16 Amperes  
India  
BIS Approved

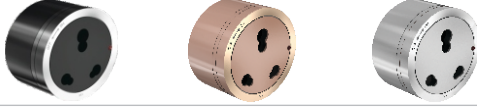

MX 6005  
13 Amperes  
BS

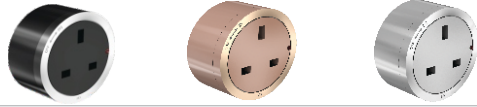

MX 6006  
5V, 2400 mA  
USB Charger



MX 6007-20W  
MX 6008-30W  
USB C+A  
Fast Charger



MX 6011  
16 Amperes  
Plug With Fuse



## MULTIMEDIA CONNECTOR



MX 6031  
Cat 3 Voice



MX 6032  
USB 3.0



MX 6033  
USB 2.0



MX 6034  
VGA 15 Pin



MX 6035  
Aux / Stereo  
3.5 mm



MX 6037  
Display Port



MX 6039  
C+A 18W  
(3.1Amp)



MX 6041  
Cat-6 / CAT-6A  
Data



MX 6042  
HDMI (4K)



MX 6043  
USB Type C



MX 6045  
USB Charger  
A+C PD 30W  
(5 AMP)



MX 6045A  
USB Charger  
A+C PD 35W  
(5 AMP) GaN Support



MX 6045B  
USB Charger  
C+C PD 68W  
GaN Support



MX 6046  
C+A PD 30W  
Digital Display



MX 6047  
Blank Plate



MX 6048  
Access  
Door Switch



MX 6049  
FLUSH  
ILLUMINATED  
6 Amperes  
ON/OFF Switch



MX 6049A  
FLUSH  
ILLUMINATED  
16 Amperes  
ON/OFF Switch



MX 6050  
WIRELESS PCB 15W



# Modular Power Tracks

## MX NUEVO S68

### UNDER DESK POWER & DATA TRACK

The MX NUEVO S68 Under Desk Modular Track Series offers an ideal solution for power and data installations, providing easy access to power beneath the workstation and offering convenience for any under-desk application. Its modular design, including customizability to any plug or multimedia socket configuration, and adjustable to fit specific length requirements. Suitable for various applications, including research facilities, libraries, laboratories, workshop desks, and more.

#### SPECIFICATION

##### Electrical

Rated Voltage : 250V— Single-phase

Rated Current : 32 Amps (Max)

USB Charging: 2 A Type Ports, 5V-2400mA

(Side Caps)

Frequency : 50 / 60Hz

Terminal Capacity : 1.25 mm<sup>2</sup> - 4 mm<sup>2</sup>

##### Material

Track Housing : Anodized Aluminum

End Cap : Polycarbonate

Busbar Carrier : Polycarbonate

Conductor : Phosphor Bronze (Copper)

Finish : Black & Silver

##### Size

Standard Length : 400mm-1200mm (refer table)

Customization : Lengths & configuration available upon request



#### Mounting Features

##### MX Nuevo S68

MX No.	Sizes	Dimensions
6303	400mm	68 x 68
6303 A	500mm	68 x 68
6303 B	600mm	68 x 68
6303 C	800mm	68 x 68
6303 D	900mm	68 x 68
6303 E	1000mm	68 x 68
6303 F	1200mm	68 x 68

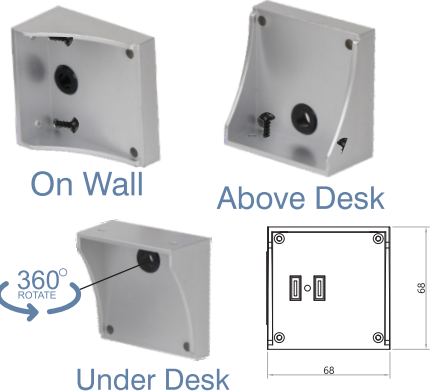

#### Customized Multimedia & Sockets on Request :

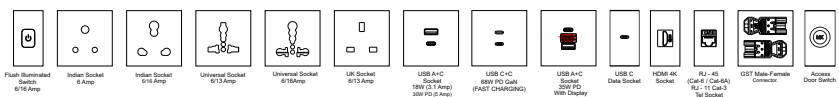

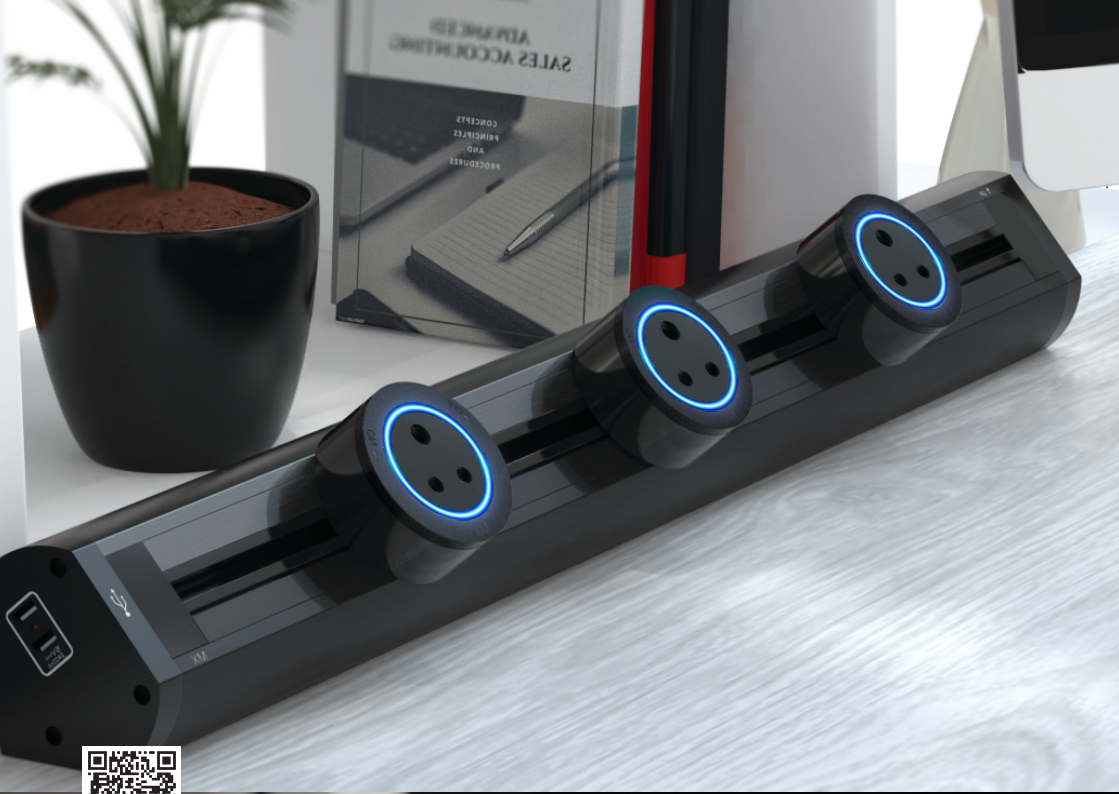

# Modular Power Tracks

## MX NUEVO D88

### DESKTOP POWER & DATA TRACK

The MX D88 Desktop Modular Track Series presents an ideal solution for power and data installations, providing convenient access to power from the above tables and catering to all desktop applications. The end cap with USB charging ensures effortless connectivity and efficient space management. Desktop Modular Track is an ideal choice for workspace environments. They stand as the most popular solution for streamlined power and cable management, adjustable to fit specific length requirements

#### SPECIFICATION

##### Electrical

Rated Voltage : 250V— Single-phase  
 Rated Current : 32 Amps (Max)  
 USB Charging: 2 A Type Ports, 5V-2400mA (Side Caps)  
 Frequency : 50 / 60Hz  
 Terminal Capacity : 1.25 mm<sup>2</sup> - 4 mm<sup>2</sup>

##### Material

Track Housing : Anodized Aluminum  
 End Cap : Polycarbonate  
 Busbar Carrier : Polycarbonate  
 Conductor : Phosphor Bronze (Copper)  
 Finish : Black & Silver

##### Size

Standard Length : 400mm-1200mm (refer table)  
 Customization : Lengths & configuration available upon request



#### MX Nuevo D88

MX No.	Sizes	Dimensions
6304	400mm	88 x 85
6304 A	500mm	88 x 85
6304 B	600mm	88 x 85
6304 C	800mm	88 x 85
6304 D	900mm	88 x 85
6304 E	1000mm	88 x 85
6304 F	1200mm	88 x 85

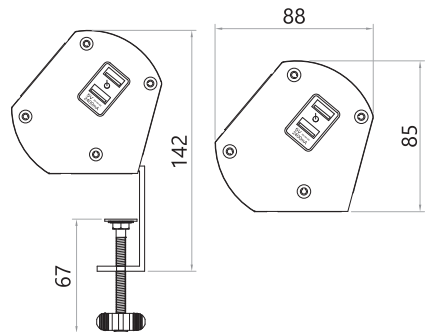

#### Customized Multimedia & Sockets on Request :

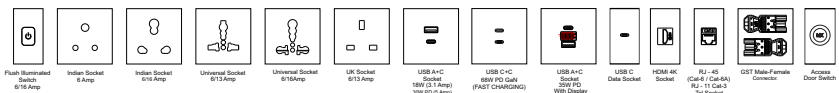





# MX Freestanding TOWER TRACK

Freestanding Tower Tracks provide a stable and convenient solution for sharing power in any space. Their flexible design allows them to seamlessly integrate into any environment, bringing power and USB charging to previously unpowered areas. Supporting a wide variety of international sockets and offering optional integrated USB-A, USB-C charging ports and wireless charging, the Tower Tracks is ideal for situations where power needs to be relocated, making it perfect for open spaces inside or in front of experience centers, living rooms, lounges, public buildings, concourses and breakout areas. Customizable to any plug or multimedia socket configuration and adjustable to fit specific length requirements.

## SPECIFICATION

### Electrical

Rated Voltage : 250V— Single-phase  
 Rated Current : 16 Amperes (Max)  
 USB Charging: 2 A Type Ports, 5V-2400mA  
 USB Charging: Type C & A PD 30W  
 Frequency : 50 / 60Hz

### Material

Profile Housing : Anodized Aluminum  
 End Cap : Polycarbonate  
 Busbar Carrier : Polycarbonate  
 Conductor : Phosphor Bronze (Copper)  
 Finish: Silver & Black

### Size

Standard Track : 400mm  
 Customization : Available upon request



ONE WAY  
MX 6400 / MX 6401



TWO WAY  
MX 6402 / MX 6403



THREE WAY  
MX 6404 / MX 6405

## MX FREESTANDING TOWER TRACK

MX No.	USB A	USB A & C	Dimensions
6400	YES	--	438 x 150 x 140
6401	--	YES	438 x 150 x 140
6402	YES	--	438 x 150 x 140
6403	--	YES	438 x 150 x 140
6404	YES	--	438 x 150 x 140
6405	--	YES	438 x 150 x 140

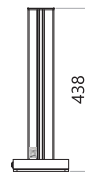

1 WAY



2 WAY



3 WAY



# MX Freestanding POWER POLE

Freestanding Power Pole offer stable and convenient power-sharing in any space, featuring automatic power cut-off protection in case of a fall. This flexible solution seamlessly integrates power and USB charging into previously unpowered areas. With universal sockets, HDMI, Cat-6, and optional integrated USB ports, the Power Pole is perfect for open spaces, including experience centers, living rooms, lounges, public buildings, concourses, and breakout areas. Customizable to any plug or multimedia socket configuration and adjustable to fit specific length requirements.

## SPECIFICATION

### Electrical

Rated Voltage : 250V— Single-phase  
 Rated Current : 32 Amps (Max) & 6/16 Amps (Max)  
 Wireless Charger : 15 Watts  
 Frequency : 50 / 60 Hz  
 1 USB A + 1 USB C : 30W PD Fast Charging  
 1 USB A + 1 USB C : 30W PD Fast Charging  
 with Voltage Display

RJ-45 : CAT-6

Port : HDMI

### Size

Standard Track : 400mm  
 Customization : Available upon request

### Material

Profile Housing : Anodized Aluminum, ABS, FRP, GRP (Flame retardant)  
 Conductor : Phosphor Bronze (Copper)  
 End Cap & Bus bar Carrier: Polycarbonate  
 Finish: Silver - White - Black

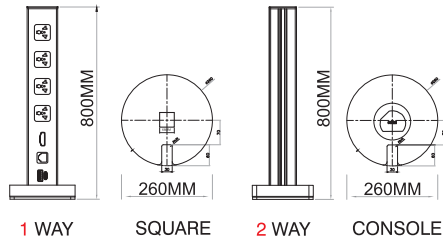

## MX FREESTANDING POWER POLE

MX No.	Universal Socket 6-13A	Power Track	Switch 6 A	USB A & C	USB A & C With Voltage Display	CAT 6	HDMI (4K)	Dimensions in MM
6406 Power Pole	04	-	1	Yes	-	Yes	Yes	800 x 260
6407 Power Pole	04	-	1	-	Yes	Yes	Yes	800 x 260
6408 Power Pole	-	Yes	-	Yes	-	Yes	Yes	800 x 260
6409 Power Pole	-	Yes	-	-	Yes	Yes	Yes	800 x 260
6410 Power Pole	04	-	1	Yes	--	Yes	Yes	800 x 260
6411 Power Pole	04	-	1	-	Yes	Yes	Yes	800 x 260
6412 Power Pole	-	Yes	-	Yes	-	Yes	Yes	800 x 260
6413 Power Pole	-	Yes	-	--	Yes	Yes	Yes	800 x 260
6414 Power Pole	--	Yes	1	Yes	--	--	--	800 x 260

### Customized Multimedia & Sockets on Request :

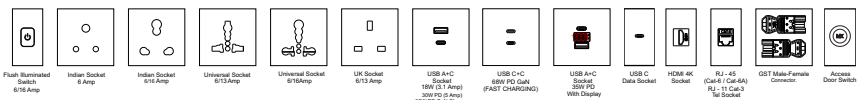



# Vertical Power and Data Pole Floor to Ceiling

MX Vertical Power and Data Pole Floor to Ceiling. Protects cable running vertically. Maintenance a neat & clean look in your office. Its rigid cable protection unique profile. Compact & Sleek Design. The ultimate power pole is to route cables from the ceiling to the floor or from the ceiling to any table or counter top. Comes in BLACK & SILVER Finish. Our MX Power Pole can be any customized length from 2.5mtrs to 4mtrs. Just PLUG-n-PLAY, with all the supported cables supplied for a plug-n-play installation. We have multiple modules as per Customer Requirement.

CEILING

## SPECIFICATION

Rated Voltage : 250 Volts — Single-phase

Rated Current : 6 -16 Amperes

Standard Finish: Black & Silver

Material : Aluminum, FRP, GRP (flame retardant)

Customization : Length Upon Request (1 WAY, 2 WAY & 4 WAY)

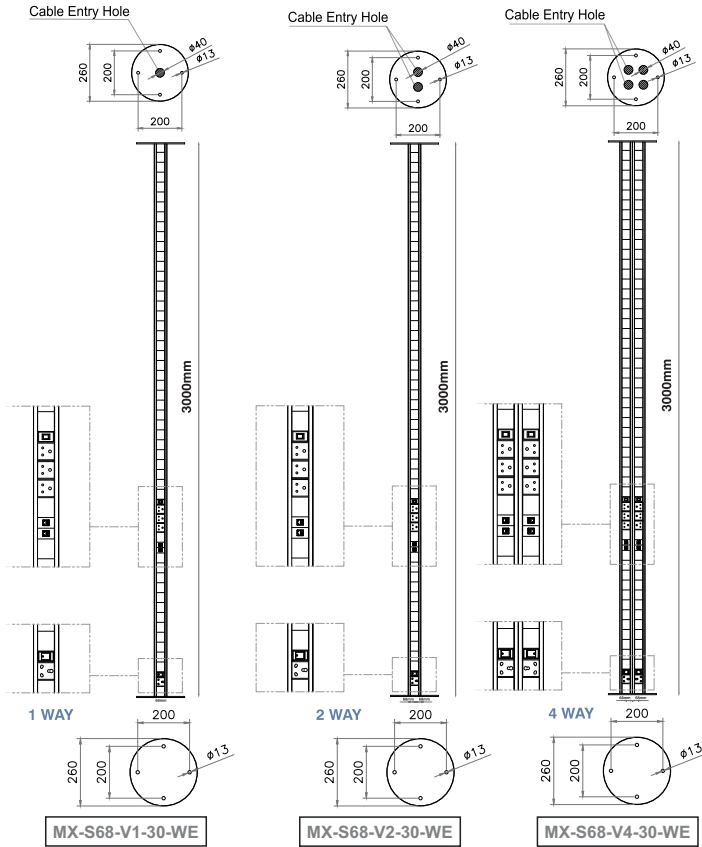

FLOOR

Customized Multimedia & Sockets on Request : (45x45mm & 22.5x45mm)

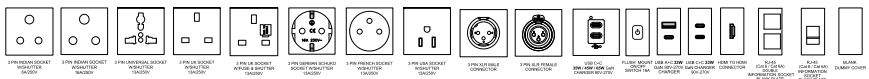





# Desktop Console

The Desktop Consoles redefine power and cable management systems with their unmatched speed of installation, strength, versatility, aesthetics, and configurability. Featuring easy connectivity and space management, their end cap provides built-in USB charging for convenient access. Available in BIS standard Indian Socket (6 & 16 Amperes) with USB A 3.0, USB A + C, & USB C charging sockets, the Desktop Consoles are an ideal choice for workspace environments. They stand as the most popular solution for streamlined power and cable management, customizable to any plug or multimedia socket configuration, and adjustable to fit specific length requirements.

## SPECIFICATION

### Electrical

Rated Voltage : 250V— Single-phase

Rated Current : 6-16 amps (Max)

USB Charger: 2 type A Ports 5V, 2400mA (Side Cap)

Finish: Silver - Black

Material : Aluminum, ABS, FRP, GRP (flame retardant)

Wiring : Pre -Wired 300mm Cable With Screwless Connector

Standard Pack : C type mounting clamps with fastening key.



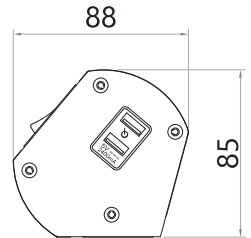
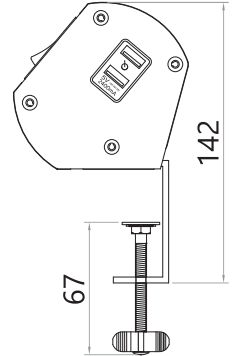











Customization : Upon Request



## Key Features :

 <p>PD Qualcomm Fast Charging for tablets &amp; laptop</p>	 <p>Customizable Configuration &amp; Mounting's</p>	 <p>Can be used above desk &amp; on wall</p>	 <p>USB Charging on End Cap</p>	 <p>Modular Design</p>
---	--	---	--	---

## Customized Multimedia & Sockets on Request :

 <p>Flush Illuminated Switch 6/18 Amp</p>	 <p>Indian Socket 6 Amp</p>	 <p>Indian Socket 6/16 Amp</p>	 <p>Universal Socket 6/13Amp</p>	 <p>Universal Socket 6/16Amp</p>	 <p>UK Socket 6/13 Amp</p>	 <p>USB A+C SOCKET 18W (2.1 Amp) 30W PD (2 Amp) 35W PD GAN Charger</p>	 <p>USB C-C Socket 60W PD GAN (FAST CHARGING)</p>	 <p>USB A+C Socket 35W PD With Display</p>	 <p>USB C Data Socket</p>	 <p>HDMI 4K Socket</p>	 <p>RJ-45 (Cat5 / Cat6)</p>	 <p>GST Male-Female Connector</p>	 <p>Access Door Switch</p>
--	--	---	---	---	---	---	--	---	--	---	--	--	--

## DESKTOP CONSOLES

MX No.	Universal Socket 6/13 Amperes	Universal Socket 6/16 Amperes	Switch 16/16 Amperes	USB A 3.0 USB C 65 Watts	USB A 3.0 USB C 95 Watts	USB A 5V 2400mA Side Cap	Dimensions in MM
4173	2		6 Amperes			2	152 x 88 x 85
4174	3		6 Amperes			2	200 x 88 x 85
4175	4		6 Amperes			2	246 x 88 x 85
4176	6		6 Amperes			2	340 x 88 x 85
4177		2	16 Amperes			2	152 x 88 x 85
4178		3	16 Amperes			2	200 x 88 x 85
4179		4	16 Amperes			2	246 x 88 x 85
4180		6	6 Amperes			2	340 x 88 x 85
4181	2		6 Amperes	1		2	200 x 88 x 85
4182	3		6 Amperes	1		2	246 x 88 x 85
4183	4		6 Amperes	1		2	394 x 88 x 85
4184	6		6 Amperes	1		2	388 x 88 x 85
4185	2		6 Amperes		1	2	205 x 88 x 85
4186	3		6 Amperes		1	2	251 x 88 x 85
4187	4		6 Amperes		1	2	299 x 88 x 85
4188	6		6 Amperes		1	2	393 x 88 x 85
4189		2	16 Amperes	1		2	200 x 88 x 85
4190		3	16 Amperes	1		2	246 x 88 x 85
4191		4	16 Amperes	1		2	394 x 88 x 85
4192		6	16 Amperes	1		2	388 x 88 x 85
4193		2	16 Amperes		1	2	205 x 88 x 85
4194		3	16 Amperes		1	2	251 x 88 x 85
4195		4	16 Amperes		1	2	299 x 88 x 85
4196		6	16 Amperes		1	2	393 x 88 x 85

## DESKTOP CONSOLES ROTATABLE SOCKETS 180°

MX No.	Universal Socket 6/13 Amperes	Switch 6 Amperes	USB A 3.0 USB C 65 Watts	USB A 3.0 USB C 95 Watts	USB A 5V 2400mA Side Cap	Dimensions in MM
4197	2	6 Amperes			2	184 x 88 x 85
4198	3	6 Amperes			2	234 x 88 x 85
4199	4	6 Amperes			2	284 x 88 x 85
4200	6	6 Amperes			2	384 x 88 x 85
4201	2	6 Amperes	1		2	232 x 88 x 85
4202	3	6 Amperes	1		2	282 x 88 x 85
4203	4	6 Amperes	1		2	332 x 88 x 85
4204	6	6 Amperes	1		2	432 x 88 x 85
4205	2	6 Amperes		1	2	236 x 88 x 85
4206	3	6 Amperes		1	2	286 x 88 x 85
4207	4	6 Amperes		1	2	336 x 88 x 85
4208	6	6 Amperes		1	2	436 x 88 x 85





# Under Desk Console

The Under Desk Consoles revolutionize power management with their unparalleled features: rapid installation, exceptional strength, unmatched versatility, sleek aesthetics, and remarkable configurability. The convenient end-cap with built-in USB charging ensures easy access and efficient space utilization. Available in BIS standard Indian Socket (6 & 16 Amperes) with USB A 3.0, USB A + C, & USB C charging sockets, the Under Desk Consoles are an ideal choice for workspace environments. They stand as the most popular solution for streamlined power and cable management, customizable to any plug or multimedia socket configuration, and adjustable to fit specific length requirements.

## SPECIFICATION

### Electrical

Rated Voltage : 250V— Single-phase

Rated Current : 6-16 amps (Max)

USB Charger: 2 type A Ports 5V, 2400mA (Side Cap)

Finish: Silver & Black Anodized

Material : Aluminum, ABS, FRP, GRP (flame retardant)

Wiring : Pre -Wired 300mm Cable With Screwless Connector



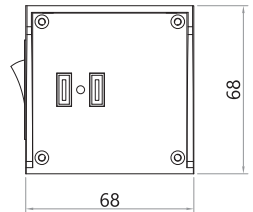











Customization : Upon Request



### Key Features :

 PD Qualcomm Fast Charging for tablets & laptop	 Customizable Configuration & Mounting's	 Can be used above desk & on wall	 USB Charging on End Cap	 Modular Design
---	--	---	--	--

### Customized Multimedia & Sockets on Request :

 Flush Illuminated Switch 6/16 Amp	 Indian Socket 6/16 Amp	 Indian Socket 6/16 Amp	 Universal Socket 6/13 Amp	 Universal Socket 6/16 Amp	 UK Socket 6/13 Amp	 USB A-C Socket 18W (3.1 Amp) 30W PD (2 Amp) 30W PD Quick Charger	 USB C-C Socket 68W PD GAN (FAST CHARGING)	 USB A-C Socket 30W PD With Display	 USB C Data Socket	 HDMI 4K Socket	 RJ-45 (Cat 5 / Cat 6)	 RJ-45 Cat 3 10 Socket	 GST Male-Female Connector	 Access Door Switch
--	--	--	---	---	--	---	---	--	---	--	---	--	--	--

## UNDER DESK CONSOLES

MX No.	Universal Socket 6/13 Amperes	Universal Socket 6/16 Amperes	Switch	USB A 3.0 USB C 65 Watts	USB A 3.0 USB C 95 Watts	USB A 5V 2400mA Side Cap	Dimensions in MM
6407	2		6 Amperes			2	235 x 68 x 68
6408	3		6 Amperes			2	285 x 68 x 68
6409	4		6 Amperes			2	335 x 68 x 68
6410	6		6 Amperes			2	435 x 68 x 68
6411		2	16 Amperes			2	235 x 68 x 68
6412		3	16 Amperes			2	285 x 68 x 68
6413		4	16 Amperes			2	335 x 68 x 68
6414		6	16 Amperes			2	435 x 68 x 68
6415	2		6 Amperes	1		2	285 x 68 x 68
6416	3		6 Amperes	1		2	335 x 68 x 68
6417	4		6 Amperes	1		2	385 x 68 x 68
6418	6		6 Amperes	1		2	485 x 68 x 68
6419	2		6 Amperes		1	2	290 x 68 x 68
6420	3		6 Amperes		1	2	340 x 68 x 68
6421	4		6 Amperes		1	2	390 x 68 x 68
6422	6		6 Amperes		1	2	490 x 68 x 68
6423		2	16 Amperes	1		2	285 x 68 x 68
6424		3	16 Amperes	1		2	335 x 68 x 68
6425		4	16 Amperes	1		2	385 x 68 x 68
6426		6	16 Amperes	1		2	485 x 68 x 68
6427	2		16 Amperes		1	2	290 x 68 x 68
6428		3	16 Amperes		1	2	340 x 68 x 68
6429		4	16 Amperes		1	2	390 x 68 x 68
6430		6	16 Amperes		1	2	490 x 68 x 68

## UNDER DESK CONSOLES ROTATABLE SOCKETS 180°

MX No.	Universal Socket 6/13 Amperes	Switch	USB A 3.0 USB C 65 Watts	USB A 3.0 USB C 95 Watts	USB A 5V 2400mA Side Cap	Dimensions in MM
6431	2	6 Amperes			2	270 x 68 x 68
6432	3	6 Amperes			2	320 x 68 x 68
6433	4	6 Amperes			2	370 x 68 x 68
6434	6	6 Amperes			2	470 x 68 x 68
6435	2	6 Amperes	1		2	350 x 68 x 68
6436	3	6 Amperes	1		2	400 x 68 x 68
6437	4	6 Amperes	1		2	450 x 68 x 68
6438	6	6 Amperes	1		2	550 x 68 x 68
6439	2	6 Amperes		1	2	355 x 68 x 68
6440	3	6 Amperes		1	2	405 x 68 x 68
6441	4	6 Amperes		1	2	455 x 68 x 68
6442	6	6 Amperes		1	2	555 x 68 x 68





# MX NUEVO C55

## IN-SURFACE POWER DISTRIBUTION UNIT WITH POWER & DATA

Engineered for effortless recessed installation, the C55 In-surface power distribution unit series seamlessly integrates power, data, and multimedia connectivity within a dedicated cable management compartment. Its sleek aluminum alloy housing makes it suitable for a variety of workstations and executive tables, making it a highly recommended solution for office and system furniture OEMs.

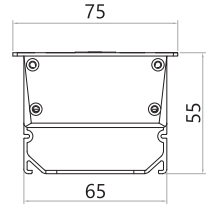
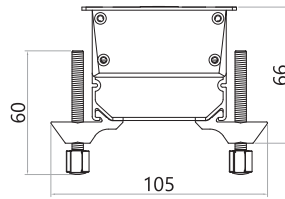

# MX NUEVO C34

## IN-SURFACE SLEEK POWER DISTRIBUTION UNIT

MX C34 In-surface power distribution unit series is engineered for simple recessed mount installation to cater power, data and multimedia in a low depth profile. A perfect solution for recessed power & data installations allowing easy access to power for tables, desk, and partitions. Plastically sleek and perfect to go with the home & office workspace.

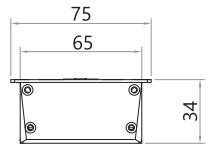
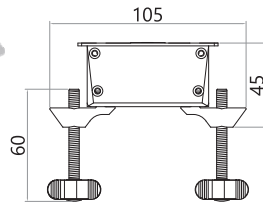

### SPECIFICATION

Electrical

Rated Voltage : 250v — Single - phase

Rated Current : 6/16 Amperes (Max)

1USB A + 1USB C : 30W PD Fast Charging

1USB A + 1USB C : 30W PD Fast Charging with Voltage Display

RJ-45 : CAT -6 / CAT 6 A

Port : HDMI 4K

Finish : Silver - Black

Wiring : Pre -Wired 300mm Cable With Screwless Connector

Material : Aluminum, ABS, FRP, GRP(Flame retardant)

Conductor : 100% Copper Contacts Plated

Size Standard length : 2/3/4 & 6 Way

Customization : Upon Request

### Key Features :

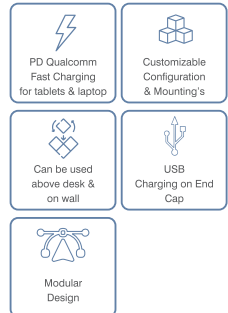

# MX NUEVO C55

MX No.	Universal Socket 6/13 Amperes	Universal Socket 6-16 Amperes	Switch	USB A & C	USB A & C With Voltage Display	CAT 6	HDMI	Dimensions Cut Size
7031	02		6 Amperes	Yes		Yes	Yes	235 x 67 x 55
7032	03		6 Amperes	Yes		Yes	Yes	290 x 67 x 55
7033	04		6 Amperes	Yes		Yes	Yes	345 x 67 x 55
7034	06		6 Amperes	Yes		Yes	Yes	424 x 67 x 55
7035		02	16 Amperes	Yes		Yes	Yes	235 x 67 x 55
7036		03	16 Amperes	Yes		Yes	Yes	290 x 67 x 55
7037		04	16 Amperes	Yes		Yes	Yes	344 x 67 x 55
7038		06	16 Amperes	Yes		Yes	Yes	424 x 67 x 55
7039	02		6 Amperes		Yes	Yes	Yes	260 x 67 x 55
7040	03		6 Amperes		Yes	Yes	Yes	315 x 67 x 55
7041	04		6 Amperes		Yes	Yes	Yes	368 x 67 x 55
7042	06		6 Amperes		Yes	Yes	Yes	424 x 67 x 55
7043		02	16 Amperes		Yes	Yes	Yes	260 x 67 x 55
7044		03	16 Amperes		Yes	Yes	Yes	315 x 67 x 55
7045		04	16 Amperes		Yes	Yes	Yes	368 x 67 x 55
7046		06	16 Amperes		Yes	Yes	Yes	424 x 67 x 55

# MX NUEVO C34

7047	02		6 Amperes	Yes		Yes	Yes	235 x 67 x 40
7048	03		6 Amperes	Yes		Yes	Yes	290 x 67 x 40
7049	04		6 Amperes	Yes		Yes	Yes	345 x 67 x 40
7050	06		6 Amperes	Yes		Yes	Yes	424 x 67 x 40
7051		02	16 Amperes	Yes		Yes	Yes	235 x 67 x 40
7052		03	16 Amperes	Yes		Yes	Yes	290 x 67 x 40
7053		04	16 Amperes	Yes		Yes	Yes	344 x 67 x 40
7054		06	16 Amperes	Yes		Yes	Yes	424 x 67 x 40
7055	02		6 Amperes		Yes	Yes	Yes	260 x 67 x 40
7056	03		6 Amperes		Yes	Yes	Yes	315 x 67 x 40
7057	04		6 Amperes		Yes	Yes	Yes	368 x 67 x 40
7058	06		6 Amperes		Yes	Yes	Yes	424 x 67 x 40
7059		02	16 Amperes		Yes	Yes	Yes	260 x 67 x 40
7060		03	16 Amperes		Yes	Yes	Yes	315 x 67 x 40
7061		04	16 Amperes		Yes	Yes	Yes	368 x 67 x 40
7062		06	16 Amperes		Yes	Yes	Yes	424 x 67 x 40

## Customized Multimedia & Sockets on Request :

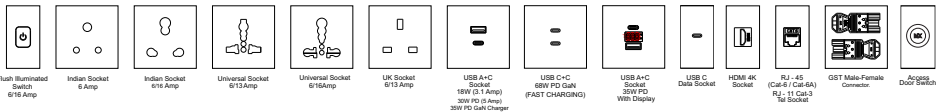



# Embedded Power & Data Socket - Screw Type

The MX Embedded Power and Data Socket Interlink, a seamless solution for power access and integrated connectivity in your workstation. Designed for a neat and organized workspace, this product comes with a dedicated power supply for a consistent and reliable source. The all-in-one power supply includes multiple sockets, USB A+C chargers, CAT 6 ports, HDMI, and a lengthy power cable. Elevate your workspace with this user-friendly solution that combines power and connectivity in one sleek package.

## SPECIFICATION

Rated Voltage : 250 Volts — Single-phase

Rated Current : 6 -13 Amperes

USB Charger: 1USB A+C 12/18/30 Watts PD Fast Charging

Finish: Black, Silver, & White Anodized

Material : Aluminum, FRP, GRP (flame retardant)

Wiring : Pre -Wired 300mm Cable With Screwless Connector

Data : HDMI, Cat6, Cat3 & USB-C

Customization : Length Upon Request



MX No.	Indian or Universal Socket	USB A+C	CAT 6	HDMI 4K	Flush Illuminated Switch 6 Amp	Dimensions	Dimensions Cut Size
7075	3	Yes	Yes	Yes	Yes	304 x 57 x 42	276 x 52

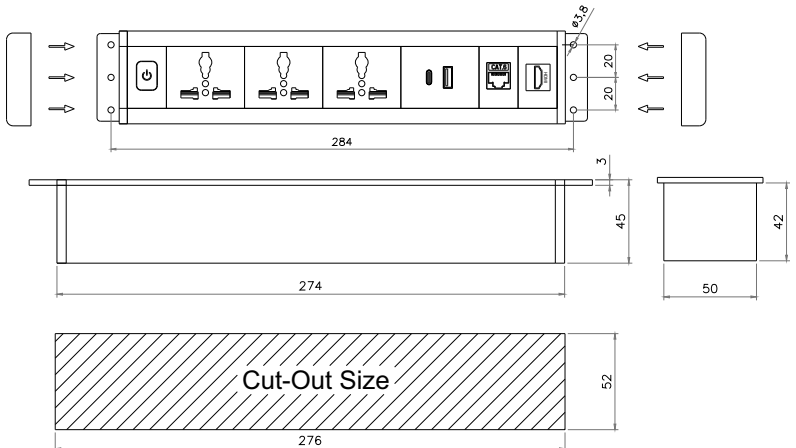

## Key Features :

- PD Qualcomm Fast Charging for tablets & laptop
- Customizable Configuration & Mounting's
- Can be used above desk & on wall
- Modular Design

## Customized Multimedia & Sockets on Request :

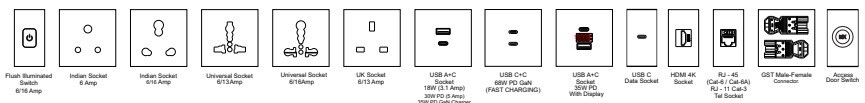



# Under Desk Socket

The MX Under Desk Socket revolutionize power management with their unparalleled features: rapid installation, exceptional strength, unmatched versatility, sleek aesthetics, and remarkable configurability. space utilization. Available in BIS standard Indian Socket (6 & 16 Amperes) with USB A 3.0, USB A + C, & USB C charging sockets, the Under Desk Consoles are an ideal choice for workspace environments. They stand as the most popular solution for streamlined power and cable management, customizable to any plug or multimedia socket configuration, and adjustable to fit specific length requirements.

## SPECIFICATION

Rated Voltage : 250V— Single-phase

Rated Current : 6-16 amps (Max)

USB Charger: 2 type A Ports 5V, 2400mA

Finish: Black Anodized

Material : Aluminum, FRP, GRP (flame retardant)

Wiring : Pre -Wired 300mm Cable With Screwless Connector

Customization : Length Upon Request



MX No.	Indian or Universal Socket	USB A+C	CAT 6	HDMI 4K	Flush Illuminated Switch 16 Amp	Dimensions
7077	3	Yes	Yes	Yes	Yes	331 x 57 x 45

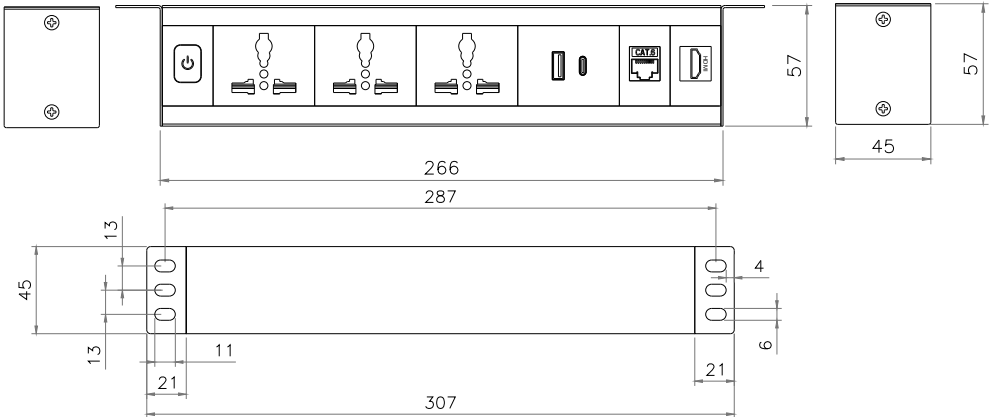

## Key Features :

- PD Qualcomm Fast Charging for tablets & laptop
- Customizable Configuration & Mounting's
- Can be used above desk & on wall
- USB Charging on End Cap
- Modular Design

## Customized Multimedia & Sockets on Request :

- Flush Illuminated Switch 6/16 Amp
- Indian Socket 6 Amp
- Indian Socket 6/16 Amp
- Universal Socket 6/13Amp
- Universal Socket 6/16Amp
- UK Socket 6/13 Amp
- USB A+C Socket 18W (3.1 Amp) 20W PD (3-4.5) 30W PD GaN Charger
- USB C+C 66W PD GaN (FAST CHARGING)
- USB A+C Socket 35W PD With Display
- USB C Data Socket
- HDMI 4K Socket
- RJ-45 Cat.5 / Cat.6A RJ-11 Cat.3 Tel Socket
- GST Male-Female Connectors
- Access Door Switch





# Power Cubby Slider Flap

The Power Cubby with Slider Flap boasts quick and simple installation. Shrouded screw terminals simplify power connections, while feed-through multimedia ports ensure seamless connectivity. It comes with a wireless charging option, and the convenient sliding flap provides easy access with magnetic soft closing to keep your workspace organized. Crafted from durable aluminum alloy, this cubby seamlessly integrates into various workstation and executive table setups. It is customizable to any plug or multimedia socket configuration and adjustable to fit specific length requirements.

## SPECIFICATION

Rated Voltage : 250V~ Single Phase  
 Rated Current : 6-13 Amperes (Max)  
 USB Charger : Type A & C Ports 18, 30, 68 GaN PD Watts  
 Material : Aluminium, Polycarbonate  
 Finish Colors : Silver & Black (Anodized)  
 Rose Gold (**ON REQUEST**)  
 Wiring : Pre -Wired 300mm Cable With  
 Screwless Connector

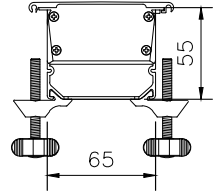

MX No.	Indian or Universal Socket	USB A + C	CAT 6	HDMI 4K	Silver or Black	Dimensions (mm)	Cutout (mm)
7005 SD-2U	2	1	1	1	Yes	275 x 87 x 55	267 x 67

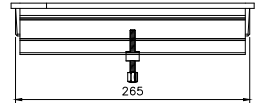
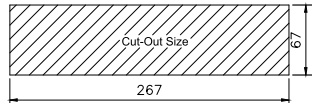
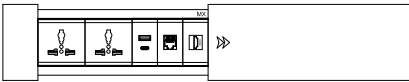

# Power Cubby Slider Flap Wireless

The Power Cubby with Slider Flap, featuring an additional wireless charger, offers quick and simple installation. Shrouded screw terminals simplify power connections, while feed-through multimedia ports ensure seamless connectivity. It includes a wireless charging option, and the convenient sliding flap provides easy access with a magnetic soft closing mechanism to keep your workspace organized. Crafted from durable aluminium alloy, this cubby seamlessly integrates into various workstation and executive table setups. It is customizable to any plug or multimedia socket configuration and adjustable to fit specific length requirements.

## SPECIFICATION

Rated Voltage : 250V~ Single Phase  
 Rated Current : 6-13 Amperes (Max)  
 USB Charger : Type A & C Ports 18, 30, 68GaN PD Watts  
 Wireless Charger : 15 Watts  
 Material : Aluminium, Polycarbonate  
 Finish Colors : Silver & Black (Anodized)  
 Rose Gold (**ON REQUEST**)  
 Wiring : Pre -Wired 300mm Cable With  
 Screwless Connector

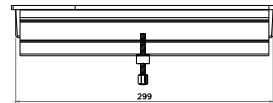

MX No.	Indian or Universal Socket	USB A + C	CAT 6	HDMI 4K	Wireless 15 W	Silver or Black	Dimensions (mm)	Cutout (mm)
7005 SDQi-2U	2	1	1	1	1	Yes	309 x 87 x 55	301 x 67

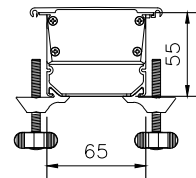
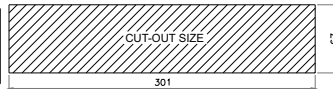
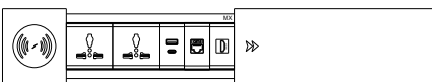

## Customized Multimedia & Sockets on Request :

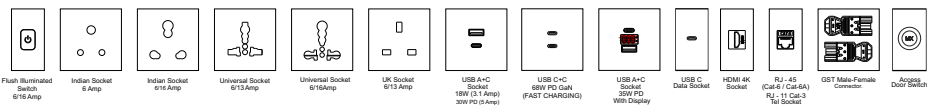

# Power Cubby Double Flap

Power Cubby with Slider Flap allows the installation processes to be adapted quickly & simply. Easy power connection with shrouded screw terminals for power and feed-through multimedia connectivity. Sliding flap function gives convenience to open and close the panel. Aluminum alloy material, suitable for varieties of workstation & executive tables.

### SPECIFICATION

- Rated Voltage : 250V~ Single Phase
- Rated Current : 6-13Amps (Max)
- USB Charger : Type A & C Ports 18, 30, 68 GaN PD Watts
- Material : Aluminium, Polycarbonate
- Finish Colors : Silver & Black (Anodized)
- Wiring : Pre -Wired 300mm Cable With Screwless Connector



MX No.	Indian or Universal Socket	USB A + C	CAT 6	HDMI 4K	Silver or Black	Dimensions (mm)	Cutout (mm)
7005 DD - 2U	2	1	1	1	Yes	275 x 87 x 55	267 x 67

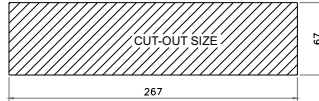
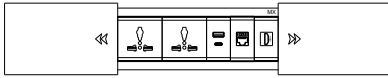
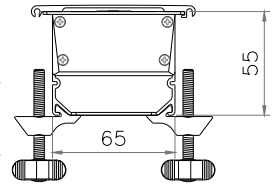
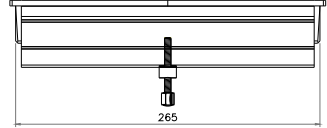

# Power Cubby Double Flap Wireless

The Power Cubby with Double Flap ensures a swift and straightforward installation process. Shrouded screw terminals simplify power connections, while feed-through multimedia ports guarantee seamless connectivity. The convenience of a double sliding flap allows easy access, facilitated by a magnetic soft closing mechanism to maintain workspace organization. Crafted from durable aluminium alloy, this cubby seamlessly integrates into a variety of workstation and executive table setups. It offers customization options for any plug or multimedia socket configuration and is adjustable to meet specific length requirements.

### SPECIFICATION

- Rated Voltage : 250V~ Single Phase
- Rated Current : 6-13Amps (Max)
- USB Charger : Type A & C Ports 18, 30, 68 GaN PD Watts
- Material : Aluminium, Polycarbonate
- Finish Colors : Silver & Black (Anodized)
- Wiring : Pre -Wired 300mm Cable With Screwless Connector



MX No.	Indian or Universal Socket	USB A + C	CAT 6	HDMI 4K	Wireless 15 W	Silver or Black	Dimensions (mm)	Cutout (mm)
7005 DDQI-2U	2	1	1	1	1	Yes	370 x 87 x 55	362 x 67

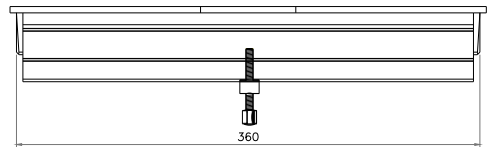
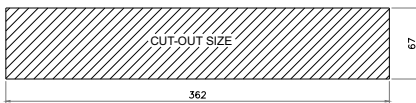
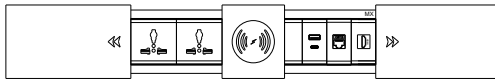
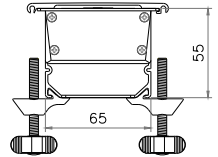

### Customized Multimedia & Sockets on Request :

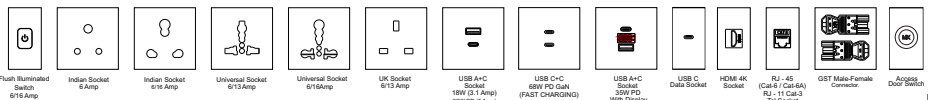

- Flush Illuminated Switch 6/16Amp
- Indian Socket 6Amp
- Indian Socket 6/16Amp
- Universal Socket 6/13Amp
- Universal Socket 6/16Amp
- UK Socket 6/13Amp
- USB A+C Socket 18W (2-1 Amp) 30W PD (2-Amp) 30W PD GaN Charger
- USB C+C Socket 68W PD GaN (FAST CHARGING)
- USB A+C Socket 30W PD With Display
- USB C Data Socket
- HDMI 4K Socket
- RJ - 45 (Cat 5 / Cat 6A) RJ - 11 Cat 3 Tel Socket
- GST Male-Female Connector
- Access Door Switch

# Power Cubby Flap Up

Power Cubby with Flap Up simplifies installation with its quick and simple design. Easy power connection is enabled by shrouded screw terminals, while feed-through multimedia ports provide seamless connectivity. The convenient up-flap function enables effortless access and closure, ensuring a clutter-free workspace. Crafted from durable aluminum alloy, this power cubby seamlessly integrates with various workstation and executive table configurations. Customizable to any plug or multimedia socket configuration, and adjustable to fit specific length requirements



## SPECIFICATION

Rated Voltage : 250V~Single phase

Rated Current : 6-13Amps (Max)

USB Charger : Type A & C Ports 18, 30, 68 GaN PD Watts

Material : Aluminium, Polycarbonate

Finish Colors : Silver & Black (Anodized)

Wiring : Pre -Wired 300mm Cable With Screwless Connector

MX No.	Indian or Universal Socket	USB A + C	CAT 6	HDMI 4K	Silver or Black	Dimensions (mm)	Cutout (mm)
7008-2U	2	1	1	1	Yes	275 x 87 x 55	267 x 67

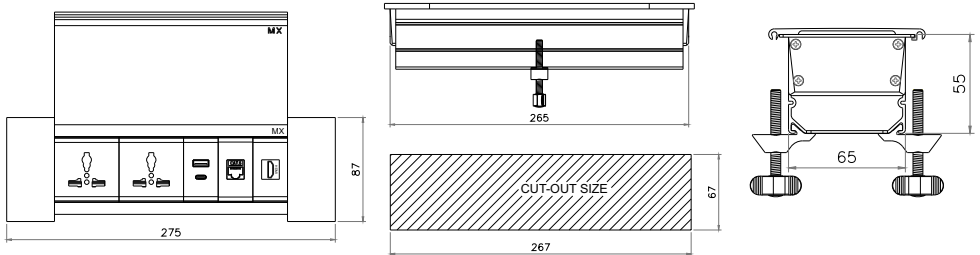

## Customized Multimedia & Sockets on Request :

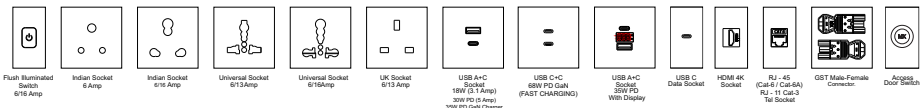

# Power Cubby Flap Up Wireless

The Power Cubby with Flap Up, featuring an additional wireless charger, simplifies installation with its quick and straightforward design. Shrouded screw terminals facilitate easy power connections, while feed-through multimedia ports ensure seamless connectivity. The convenient up-flap function enables effortless access and closure, ensuring a clutter-free workspace. Crafted from durable aluminum alloy, this power cubby seamlessly integrates with various workstation and executive table configurations. It is customizable to any plug or multimedia socket configuration and adjustable to fit specific length requirements.



## SPECIFICATION

- Rated Voltage : 250V~Single phase
- Rated Current : 6-13Amps (Max)
- USB Charger : Type A & C Ports 18, 30, 68 GaN PD Watts
- Material : Aluminium, Polycarbonate
- Finish Colors : Silver & Black (Anodized)
- Wiring : Pre-Wired 300mm Cable With Screwless Connector

MX No.	Indian or Universal Socket	USB A + C	CAT 6	HDMI 4K	Wireless 15 W	Silver or Black	Dimensions (mm)	Cutout (mm)
7008 Qi-2U	2	1	1	1	1	Yes	309 x 87 x 55	301 x 67

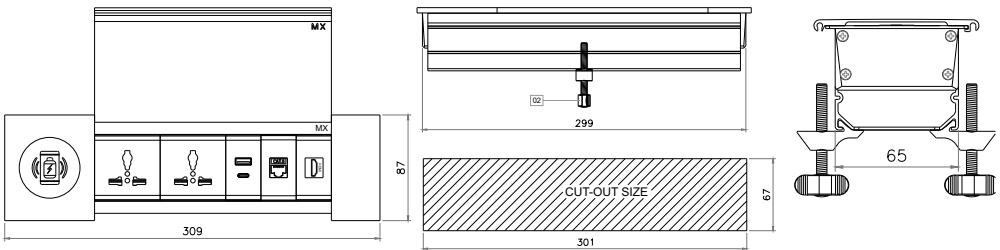

## Customized Multimedia & Sockets on Request :

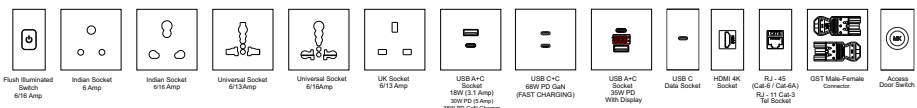



# Power Cubby Flap-Meld Sockets

Power cable cubby featuring melded sockets for seamless cable management, buffer damping for silent operation, and a convenient up-flap design, the Power Flap simplifies installation and enhances user experience. Pre-wired power code and feed-through multimedia connectivity ensure effortless setup, while the up-flap function provides easy access, cable management, and a smooth, quiet operation. Crafted from durable aluminum alloy, this power flap seamlessly integrates into diverse workstation and executive table configurations. Customizable to any plug or multimedia socket configuration, and adjustable to fit specific length requirements



## SPECIFICATION

Rated Voltage : 250V~Single phase  
 Rated Current : 6-13Amps (Max)  
 USB Charger : Type A & C Ports 18, 30, 68 GaN PD Watts  
 Material : Aluminium, Polycarbonate  
 Finish Colors : Silver & Black (Anodized)  
 Wiring : Pre -Wired 300mm Cable With Screwless Connector

MX No.	Indian or Universal Socket	USB A + C	CAT 6	HDMI 4K	Silver or Black	Dimensions (mm)	Cutout (mm)
7009	3	1	1	1	Yes	309 x 161 x 51	295 x 148

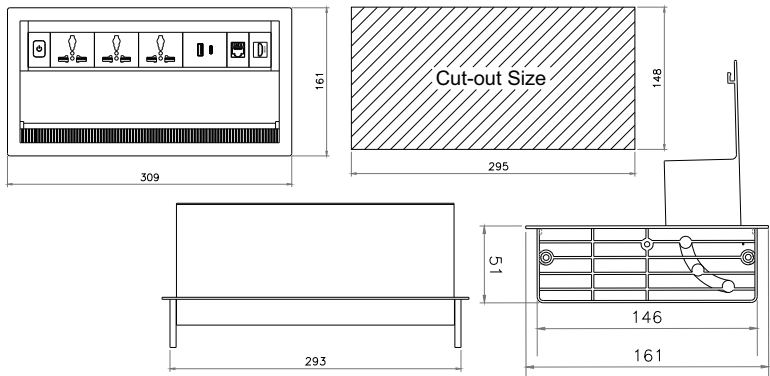

## Customized Multimedia & Sockets on Request :

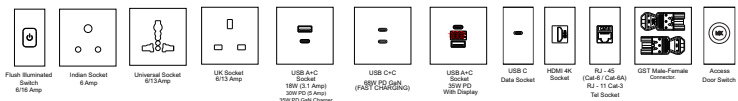



# Desktop Power Grommet

The Desk Power Grommet is a sophisticated solution designed to enhance workspace efficiency and organization. Seamlessly integrating power outlets and USB charging, it fits precisely into a standard 80mm diameter cutout, ensuring effortless installation, upgrades, and replacements. This innovative in-desk unit features easily accessible Indian or universal sockets, along with USB-A and USB-C ports offering 30W fast charging capabilities. Its adjustable clasp ring ensures a secure fit on desks, tables, and worktops up to 50mm thick, effectively eliminating cable clutter while delivering a streamlined and functional workspace experience.



- Secure Fit for Various Surfaces
- Adaptable Installation
- Clutter-Free Workspace
- Individually Configurable

## SPECIFICATION

Rated Voltage : 250V~ Single Phase

Rated Current : 6-13 Amperes

USB Charger : Type A + C

Material : Flame Retardant Nylon Glass Field

Finish Colors : Black & White

Wiring : Pre -Wired 300mm Cable With Screwless Connector

Standard pack : Locking clasp ring.

Dimension : 104 x 110 x 79.8 mm

Cutout Dimension: Ø 80 mm

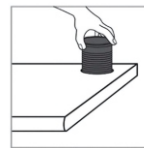
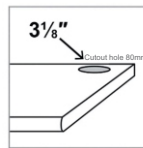
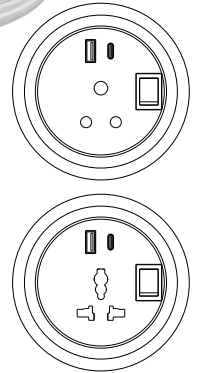
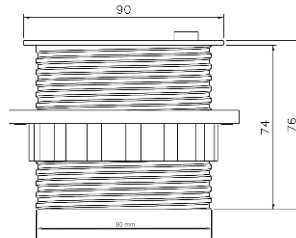

MX No.	Universal Socket 6-13 Amperes	Indian Socket	USB A+C	Wireless 15 Watts	Dual Pole Switch 6 Amperes
7071	1	-	Yes	-	Yes
7072	-	1	Yes	-	Yes

## Customized Multimedia & Sockets on Request :



INDIAN  
SOCKET  
6 AMP



UNIVERSAL  
SOCKET  
6 / 13 AMP



USB A+C  
SOCKET  
18W (3,1Amp)  
30 W PD (3Amp)  
30 W PD GaN Charger



GST  
MALE / FEMALE  
CONNECTORS

# Wireless Desktop Power Grommet

The Desk Power Grommet with Wireless Charging is an advanced solution designed to enhance workspace functionality and organization. Seamlessly integrating into a standard 80mm diameter cutout, it allows for hassle-free installation, upgrades, and replacements. This innovative in-desk unit features 15W wireless charging capability, providing a convenient, clutter-free way to power your devices. Its adjustable clasp ring ensures a secure fit on desks, tables, and worktops up to 50mm thick, delivering a sleek and efficient workspace experience.



**MX 7073  
BLACK**



**MX 7073  
WHITE**

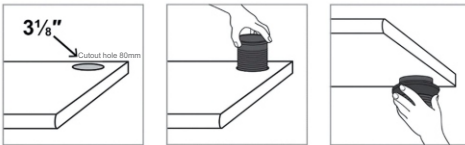

- Secure Fit for Various Surfaces
- Adaptable Installation
- Clutter-Free Workspace
- Individually Configurable

## SPECIFICATION

Material : Flame Retardant Nylon Glass Field

Finish Colors : Black & White

Wireless Charger : 15 Watts

Standard pack : Locking clasp ring.

Dimension : 104 x 110 x 79.8 mm

Cutout Dimension: Ø 80 mm

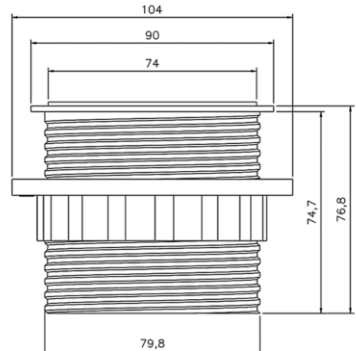
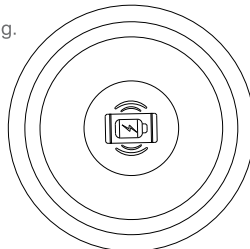
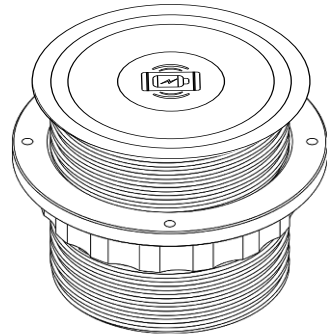

## Sockets :



Wireless  
15 W



GST  
MALE / FEMALE  
CONNECTORS

# Desktop Power Grommet with Manual Pass Through

The MX 4-way manual cable pass through is a sophisticated, furniture-mounted round cable pass-through, designed for easy installation into table or podium tops. This sleek retractor is ideal for managing up to four cables, with a maximum cable diameter of 8 mm and a minimum strain relief width of 9 mm. A cutout of 80 mm is required for installation. Perfect for maintaining a clean, organized workspace, this cable management solution combines functionality with a polished, professional appearance.



**MX 7074  
BLACK**



**MX 7074  
WHITE**

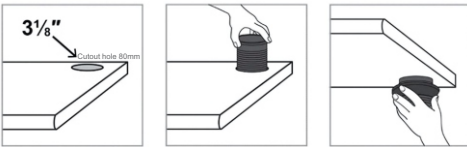

- Secure Fit for Various Surfaces
- Adaptable Installation
- Clutter-Free Workspace
- Individually Configurable

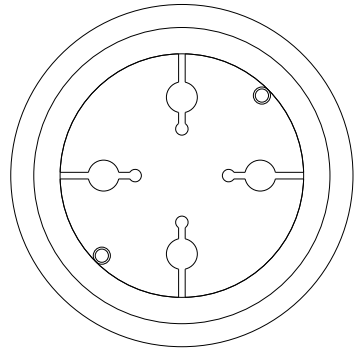

## SPECIFICATION

Material : Flame Retardent Nylon Glass Field  
 Finish Colors : Black & White  
 4 Way cable Pass Through  
 Standard pack : Locking clasp ring.  
 Dimension : 104 x 110 x 79.8 mm  
 Cutout Dimension: Ø 80 mm

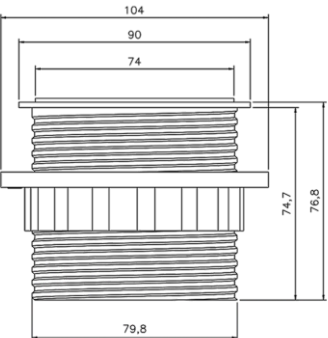

## Sockets :



Wireless  
15 W



GST  
MALE / FEMALE  
CONNECTORS



# Pluto Dock

PLUTO redefines power and data connectivity in informal spaces with unparalleled versatility. Its 3 outlets and 180° socket access provide seamless power and device charging for small teams using AC mains plugs, USB-A, and USB-C Power Delivery. This product effortlessly blends style and function to meet the growing demand for easily accessible mobile device charging. Available in polished white, black, silver, and 8 vibrant colors, PLUTO perfectly complements any interior design.

- 180° Socket Access
- Infinitely Customizable
- Versatile Installation
- Radiant LED Glow



## SPECIFICATION

Rated Voltage : 250V~ Single Phase

Rated Current : 6-13A

USB Charger : Type A & C Ports 18, 30 PD, 30 GaN PD Watts

Material : Polycarbonate

Finish Colors : Black / White

Wiring : IEC Locking Connector With Power Cord 1.5mtr

Dimension : 152 x 76mm

Cutout Dimension: PCD-120 mm With 3 Screw for Lock

MX No.	Universal or Indian Socket	USB A+C	LED	HDMI or Cat-6
7067	2	1	-	-
7068	2	1	Yes	-
7069	2	-	-	1
7070	2	-	Yes	1

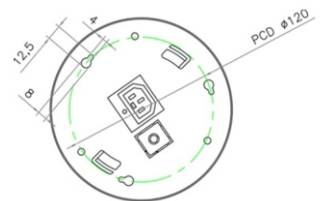
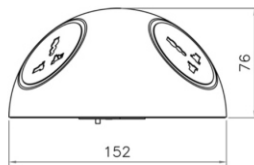
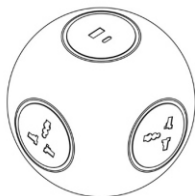

## Customized Multimedia & Sockets on Request :



INDIAN SOCKET  
6 AMP



UNIVERSAL SOCKET  
6 / 13 AMP



UK SOCKET  
13 AMPS



USB A+C SOCKET  
18W (3.1Amp)  
30W PD (5Amp)  
30 W PD GaN Charger



HDMI 4K SOCKET



RJ - 45 (Cat-6 / Cat-6A)  
RJ - 11 Cat-3  
Tel Socket

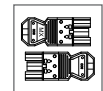

GST MALE / FEMALE CONNECTORS



# Pluto Grommet

PLUTO with Locking clasp ring revolutionizes power and data connectivity in casual environments, offering unmatched versatility. With 3 outlets and 360° socket access, it ensures seamless power and device charging for small teams utilizing AC mains plugs, USB-A, and USB-C Power Delivery. This product seamlessly combines style and functionality to address the increasing need for convenient mobile device charging. Available in polished white, black, silver, and a selection of 8 vibrant colors, PLUTO perfectly harmonizes with any interior design.

- 180° Socket Access
- Infinitely Customizable
- Versatile Installation
- Radiant LED Glow

## SPECIFICATION

Rated Voltage : 250V~ Single Phase

Rated Current : 6-13A

USB Charger : Type A & C Ports 18, 30 PD, 30 GaN PD Watts

Material : Polycarbonate

Finish Colors : Black / White

Wiring : Pre -Wired 300mm Cable With Screw Less Connector

Standard pack : Locking clasp ring.

Dimension : 152 x 149 x 79.5mm

Cutout Dimension: Ø 80 mm



MX No.	Universal or Indian Socket	USB A+C 30 W PD	LED	HDMI or Cat-6
7063	2	1	–	–
7064	2	1	Yes	–
7065	2	–	–	1
7066	2	–	Yes	1

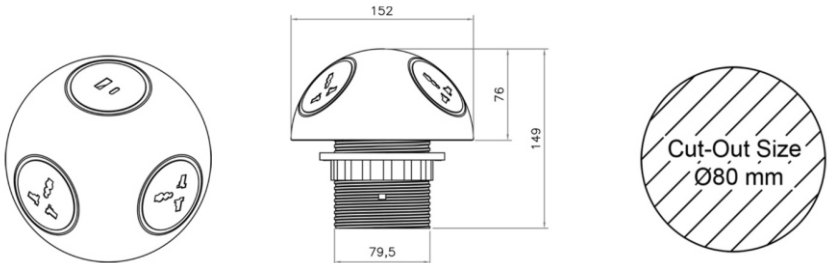

## Customized Multimedia & Sockets on Request :



INDIAN SOCKET  
6 AMP



UNIVERSAL SOCKET  
6 / 13 AMP



UK SOCKET  
13 AMPS



USB A+C SOCKET  
18W (3.1Amp)  
30W PD (5Amp)  
30 W PD GaN Charger



HDMI 4K SOCKET



RJ - 45 (Cat-6 / Cat-6A)  
RJ - 11 Cat-3  
Tel Socket



GST MALE / FEMALE CONNECTORS



# Power Post Push-Up

The Power Post Push-Up features a hydraulic bar pop-up mechanism for effortless pop-up functionality just press down to activate. This innovative design combines universal electrical outlets with efficient charging options, making it perfect for compact spaces. With a sleek 65mm diameter, it seamlessly raises or lowers with a simple press. It offers comprehensive connectivity and is equipped with USB-A ports, a 20W USB-C port with Power Delivery for rapid charging, HDMI 4K, and RJ-45 sockets. This compact, retractable solution is ideal for powering devices in homes, offices, and commercial settings.

## SPECIFICATION

2 Universal 6/13 Amperes Power Socket  
 With 3 x 1.5 mm<sup>2</sup> Cord 1.6 Meter  
 Ø170 x 280 mm Length  
 Cut Out Size - Ø65 mm

- MX 7078 - BLACK
- MX 7078A - WHITE
- MX 7078B - SILVER

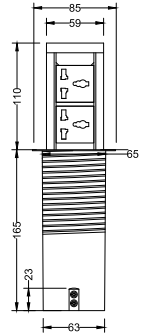

## SPECIFICATION

1 Universal 6/13 Ampere Power Socket  
 1 USB A + C 20W PD  
 Charger With 3 x 1.5 mm<sup>2</sup> Cord 1.6 Meter  
 Ø170 x 280 mm Length  
 Cut Out Size - Ø65 mm

- MX 7079 - BLACK
- MX 7079A - WHITE
- MX 7079B - SILVER

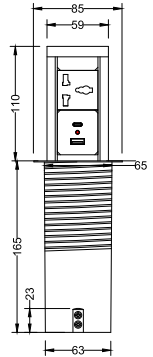

## SPECIFICATION

2 Universal 6/13 Ampere Power Socket  
 1 USB A + C 20W PD  
 Charger With 3 x 1.5 mm<sup>2</sup> Cord 1.6 Meter  
 Ø230 x 385 mm Length  
 Cut Out Size - Ø65 mm

- MX 7080 - BLACK
- MX 7080A - WHITE
- MX 7080B - SILVER

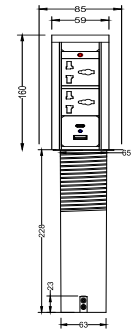

MX No.	Universal or Indian Socket	USB A+C 30 W PD	HDMI or Cat-6	WIRELESS CHARGING
7078	2	-	-	-
7079	1	1	-	-
7080	2	1	-	-

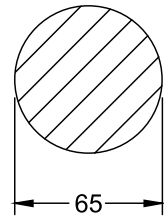

# Power Post Push-Up Wireless

The Power Post Push-Up Wireless includes 15W wireless charging, offering a convenient, cable-free power solution. Featuring a hydraulic bar mechanism for effortless pop-up functionality, it activates with a simple press. This innovative design combines universal electrical outlets with efficient charging options, making it perfect for compact spaces. With a sleek 65mm diameter, it seamlessly raises or lowers as needed. It offers comprehensive connectivity with USB-A ports, a 20W USB-C port with Power Delivery for rapid charging, HDMI 4K, and RJ-45 sockets. This compact, retractable solution is ideal for powering devices in homes, offices, and commercial settings.

## SPECIFICATION

2 Universal 6/13 Ampere Power Socket  
 1 USB A + C 20W PD Charger  
 1 Top Wireless Charger 15W  
 3 x 1.5 mm<sup>2</sup> Cord 1.6 Meter  
 Ø230 x 385 mm Length  
 Cut Out Size - Ø64 mm

- MX 7081 Qi - BLACK
- MX 7081A Qi - WHITE
- MX 7081B Qi - SILVER

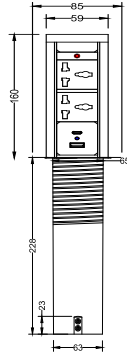

## SPECIFICATION

2 Universal 6/13 Ampere Power Socket  
 1 HDMI (4K) W/Cable  
 1 RJ-45 (CAT 6) W/Cable  
 1 Top Wireless Charger 15W  
 With 3 x 1.5 mm<sup>2</sup> Cord 1.6 Meter  
 Ø230 x 385 mm Length  
 Cut Out Size - Ø64 mm

- MX 7082 Qi - BLACK
- MX 7082A Qi - WHITE
- MX 7082B Qi - SILVER

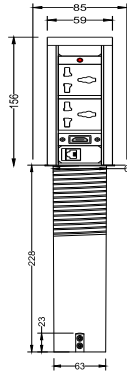

## SPECIFICATION

1 Universal 6/13 Ampere Power Socket  
 1 USB A + C 20W PD Charger  
 1 HDMI (4K) W/Cable  
 1 RJ-45 (CAT 6) W/Cable  
 1 Top Wireless Charger 15W  
 With 3x1.5 mm<sup>2</sup> Cord 1.6 Meter  
 Ø230 x 385 mm Length  
 Cut Out Size - Ø65 mm

- MX 7083 Qi - BLACK
- MX 7083A Qi - WHITE
- MX 7083B Qi - SILVER

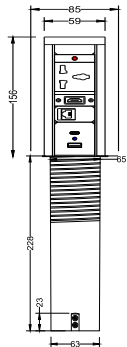

MX No.	Universal or Indian Socket	USB A+C 30 W PD	HDMI or Cat-6	WIRELESS CHARGING
7081 Qi	2	1	-	Yes
7082 Qi	2	-	1	Yes
7083 Qi	1	1	1	Yes

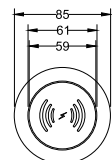
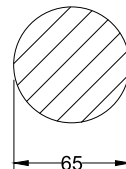

# Power Post Push-Up Wireless

The Power Post comes with a hydraulic bar pop-up mechanism, simply push the top panel to pop the unit up for use. A unique product for electrical outlets and charging electronic devices, by using patch cord or wireless. The wireless feature is compatible with all devices that comply with Qi standards. This product delivers 3 universal electrical receptacles, 1 USB A type & 1 USB C type with power delivery 20 Watts and a wireless charger on top

## SPECIFICATION

- Rated Voltage : 250V~ Single Phase
- Rated Current : 6-13A
- Universal Sockets : 6/10/13Amps x 3
- USB Charger : 1 USB ports A type 20 Watts (Single Use)
- USB Charger : 1 USB ports C type 20 Watts (Single Use)
- Wireless Charger : 15 Watts
- Material : Polycarbonate
- Finish Colors : Glass Black
- Wiring: 3 x 1mm<sup>2</sup> Cable 1.5 meter with 6 Amps Plug.
- Standard pack : Locking clasp ring.
- Dimension : Ø 128 mm x 160 mm
- Cutout Dimension: Ø 110mm

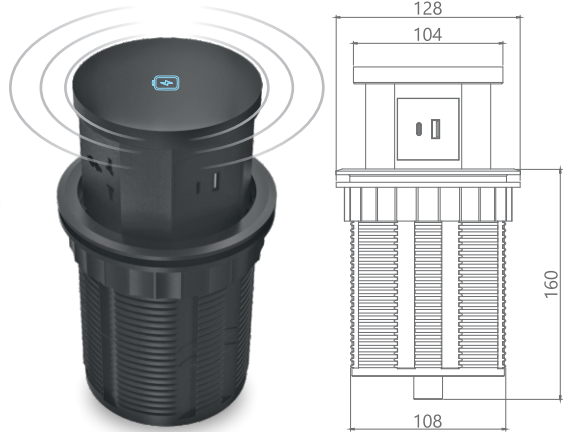

GLASS BLACK  
MX 7011

# Power Post Touch-Up Wireless Feather Touch Light

The Power Post sets itself apart with its unique touch-activated pop-up mechanism, allowing you to easily access power by simply "figuring touching" the switch icon on the top panel. This innovative unit combines both wired and wireless charging capabilities, featuring four universal electrical outlets, two high-power USB-A ports (3.0Amps), two USB-C ports with Power Delivery (30W), and a Qi-compatible wireless charging pad on top (15W). Its compact, retractable design, built from durable engineered polycarbonate, makes it the perfect multi-functional solution for charging multiple devices at home, offices, and commercial counters, maintaining a clean and organized workspace.

## SPECIFICATION

- Rated Voltage : 250V~ Single Phase
- Rated Current : 6-13A
- Universal Sockets : 6/10/13Amps x 4
- USB Charger : 2 USB ports A type 20 Watts (Single Use)
- USB Charger : 2 USB ports C type 20 Watts (Single Use)
- Wireless Charger : 15 Watts
- Material : Polycarbonate
- Finish Colors : Glass Black
- Wiring: 3 x 1mm<sup>2</sup> Cable 1.8 mtrs with 6 Amps Plug.
- Standard pack : Locking clasp ring.
- Dimension : Ø 145 mm x 120 mm
- Cutout Dimension: Ø 120mm



GLASS BLACK  
MX 7012

# Furniture Nested Power Receptacles

Furni Nested Power Receptacles with a hydraulic bar pop-up mechanism discreetly integrate power and charging solutions into your furniture without compromising its design aesthetic. The customizable surround frame blends seamlessly with your décor, ensuring a perfect match. This versatile product offers universal power sockets, fast-charging USB-C and USB-A ports (30W total PD), and optional Cat6 data or HDMI ports to cater to your connectivity needs.

## SPECIFICATION

Rated Voltage : 250V~ Single Phase  
 Rated Current : 6-13A  
 Universal Sockets : 6/10/13Amps x 4  
 USB Charger : 2 USB ports A type 15 Watts (Single Use)  
 USB Charger : 1 USB ports C type 15 Watts (Single Use)  
 USB Volt/Current : 5V/3.1Amps  
 Material : Polycarbonate  
 Finish Colors : MX 7010 - Glass Silver Grey,  
 MX 7010A - Glass Black & MX 7010B - Glass White  
 Wiring : 3 x 1 mm<sup>2</sup> Cable 1.8 meter with 6 Amps Plug.  
 Standard pack : Locking clasp ring.  
 Dimension : Ø 92 mm x 173 mm  
 Cutout Dimension : Ø 90 mm

- MX 7010
- MX 7010A
- MX 7010B

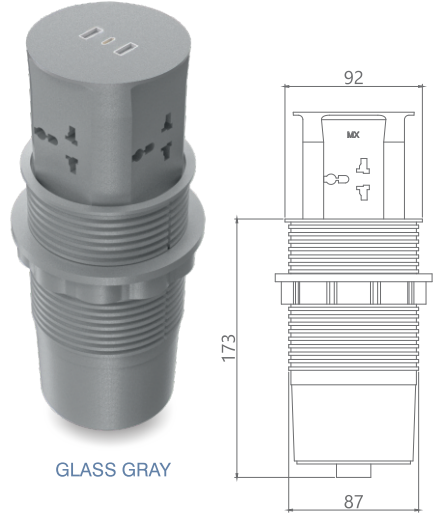

# Furniture Push-Up Mini Wireless

The Power Post boasts a hydraulic bar pop-up mechanism for easy activation by simply pushing the top panel. This versatile product caters to your wireless charging needs, featuring a 15W Qi-compatible wireless charging pad on top. Additionally, it offers convenient charging options for wired devices with a 15W USB-A port and a 20W USB-C port with Power Delivery. The compact, retractable design, crafted from high-grade engineered polycarbonate, makes it multi-functional and ideal for charging various devices at home and office, ensuring a clean and organized workspace.

- Spring-Loaded Pop-Up Mechanism
- Wireless Charging
- Versatile Wired Charging Options
- Compact and Retractable Design

## SPECIFICATION

Rated Voltage : 250V—Single Phase  
 USB Charger : USB C 20W + A 18W Ports  
 Wireless Charger : 15W  
 Material : Polycarbonate  
 Finish Colors : White  
 Wiring : DC 24V (Max) 5.5 X 2.1 mm  
 Standard pack : With Adaptor  
 Dimension : 75mm x 113 mm  
 Cutout Dimension : Ø 62 mm

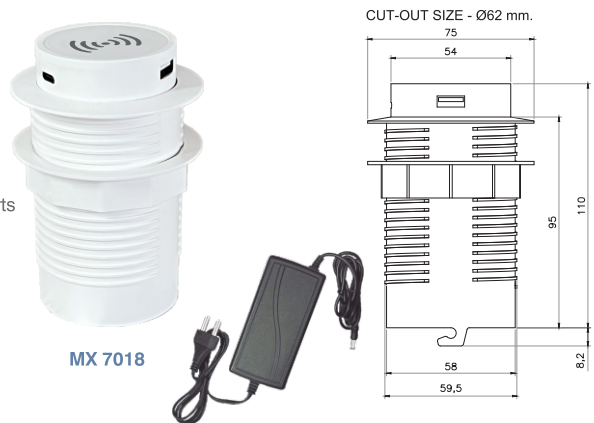



# Solo Power Manager

The Solo Power Manager is a compact, single-outlet power solution designed to enhance any solo workspace. It offers a universal electrical receptacle, fast-charging USB-A and USB-C (30W total), Cat 6 networking, and an HDMI port, making it ideal for home offices, studios, study tables, bedside tables, leisure sofas, and more. This versatile unit can be panel-mounted to any surface, bringing essential power and connectivity right where you need it.



## SPECIFICATION

Rated Voltage : 250V~Single phase

Rated Current : 6-13 Amperes (Max)

USB Charger : A+C 18, 30 PD Watts

Material : Polycarbonate

Finish Colors : Black & Silver

Wiring : Pre -Wired 300mm Cable With Screwless Connector

## Configuration

1 Universal Socket ,

1 USB A+ C 30W Fast Charging,

1 Cat 6 & 1 HDMI

Dimension: 202 X 58 X 45 MM

Cutout Dimension: Cut Size - 195 X 50 (R-25)MM

Customized : Upon Request

MX No.	Universal Socket 6-13 Amperes	2 USB A + C 30 Watts	Data Cat OPTIONAL	HDMI 4K	Silver	Black	Dimensions (mm)	Cutout (mm)
7014	1	1	1	1	--	Yes	202 x 56.5 x 48	195 X 50
7014 A (Silver)	1	1	1	1	Yes	--	202 x 56.5 x 48	195 X 50

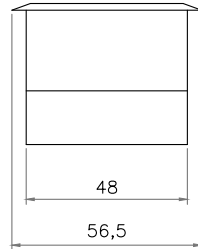
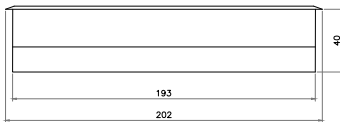
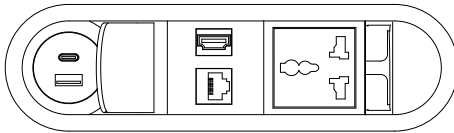

## Customized Multimedia & Sockets on Request :



INDIAN  
SOCKET  
6 AMP



UNIVERSAL  
SOCKET  
6 / 13 AMP



USB A+C  
SOCKET  
18W (3.1Amp)  
30W PD (5Amp)  
30 W PD GaN Charger



HDMI 4K  
SOCKET



RJ - 45  
(Cat-6 / Cat-6A)  
RJ - 11 Cat-3  
Tel Socket



GST  
MALE / FEMALE  
CONNECTORS

# Furniture Nested Power Receptacles

Furniture Nested Power Receptacles discreetly integrate power and charging solutions into your furniture without compromising the design aesthetic. The customizable surround frame blends seamlessly with your décor, ensuring a perfect match. This versatile product offers universal power sockets, fast-charging USB-C and USB-A ports (30W total PD), and optional Cat6 data or HDMI ports, catering to your connectivity needs.

## MX 7015



MX 7016

### SPECIFICATION

Rated Voltage : 250V~Single Phase

Rated Current : 10 Amperes (Max)

USB Charger : USB C+ A Ports PD 18-30 Watts

Material : Polycarbonate

Finish Colors : Surround Frame

Black / Silver / Wooden

Customized Finish : Available upon request

Wiring : Pre -Wired 300mm Cable With Screwless Connector

Standard pack : With Surround Plate

Standard Configuration: 2 Universal Sockets & USB Charger, A+C PD 18-30 Watts, Cat 6 / Cat 6A or HDMI (Optional)

Dimension : 182mm x 57.5mm x 43mm

Cutout Dimension: 156mm x 50mm

MX No.	Colors	Universal Socket 6-13 Amperes	USB A & C 30 Watts	CAT 6 OR HDMI	Dimensions (mm)	Cutout (mm)
7015	Receptacles Black	02	Yes	Yes	182 x 58 x 43	156 x 50
7016	Receptacles Silver Decor	02	Yes	Yes	182 x 58 x 43	156 x 50

Note : CAT 6 / CAT 6A or HDMI Port Optional

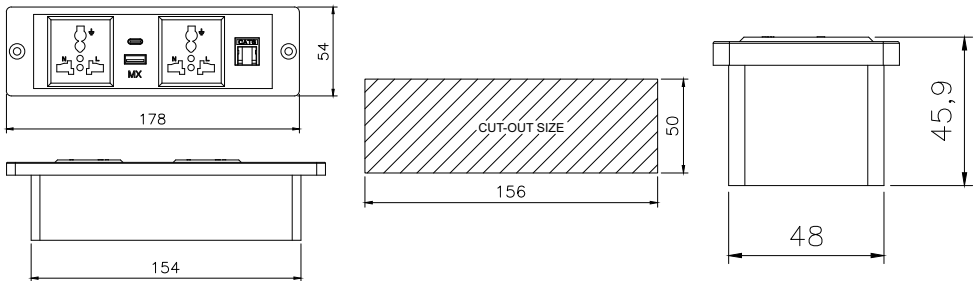

### Customized Multimedia & Sockets on Request :

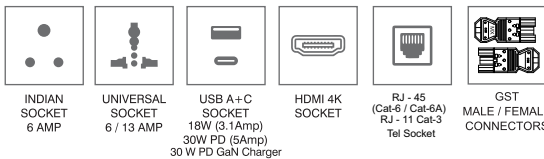



# Flip Top Push

The MX Flip Top Push is a sleek and versatile solution that powers workspaces easily and efficiently. With a simple press, the flap opens seamlessly to reveal a range of connectivity options. It features 2 universal or Indian sockets, USB-A + USB-C ports offering charging options from 12W to 30W with GaN support, along with RJ-45 (CAT-6) and HDMI 4K connectivity. An integrated 6 Amp switch adds convenience, making this unit ideal for powering, charging, and connecting in professional or personal work environments.

- Effortless Access
- Comprehensive Ports
- Integrated Control
- Customizable Sizes Available

## Configuration

- 2 Universal 6/13 Ampere Or Indian 6 Ampere Power Socket
- 1 USB A + C
- 1 RJ-45 (CAT 6)
- 1 HDMI (4K)
- Switch 6 Ampere
- Finish Colors : Black & Silver
- Pre Wired 300 mm with Screwless Connector

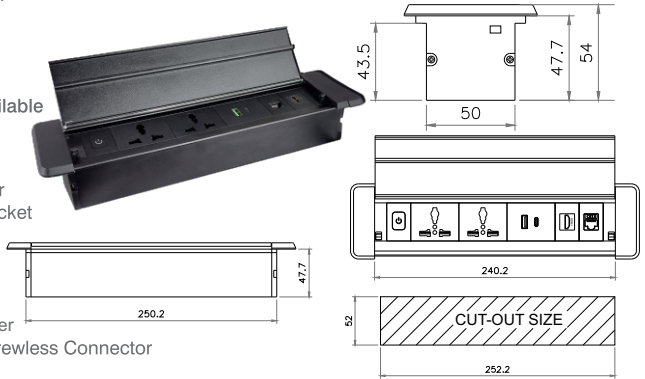

# Flip Top Push Wireless

The MX Flip Top Push wireless is a sleek and versatile solution that powers workspaces with ease and efficiency. It features 15W wireless charging for fast, cable-free convenience. With a simple press, the flap opens seamlessly to reveal a range of connectivity options, including 2 universal or Indian sockets, USB-A + USB-C ports with charging options from 12W to 30W and GaN support, as well as RJ-45 (CAT-6) and HDMI 4K connectivity. An integrated 6 Amp switch adds to its functionality, making it ideal for powering, charging, and connecting in professional or personal work environments.

- Wireless charging
- Effortless Access
- Comprehensive Ports
- Integrated Control
- Customizable Sizes Available

## Configuration

- 2 Universal 6/13 Ampere Or Indian 6 Ampere Power Socket
- 1 USB A + C
- 1 RJ-45 (CAT 6)
- 1 HDMI (4K)
- Switch 6 Ampere
- Finish Colors : Black & Silver
- Pre Wired 300 mm with Screwless Connector

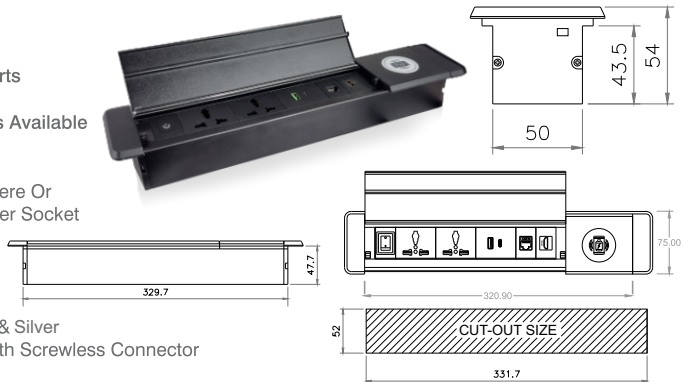

MX No.	Universal or Indian Socket	USB A+C	HDMI 4K	RJ-45 Cat 6	WIRELESS CHARGING	Silver or Black
7105	2	1	1	1	-	Yes
7106 Qi	2	1	1	1	1	Yes

## Customized Multimedia & Sockets on Request :

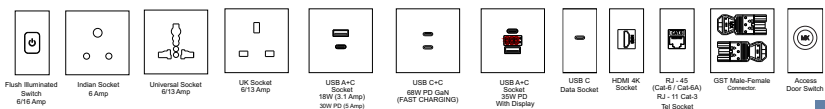

# Aero Flip

The MX Aero flip is a sophisticated and versatile solution designed to streamline workspace power and connectivity needs. With a simple press, its flap opens seamlessly to reveal an array of features, including 2 universal or Indian sockets, USB-A and USB-C ports supporting 12W to 30W charging with GaN technology, as well as RJ-45 (CAT-6) and HDMI 4K connectivity. This innovative unit is ideal for efficient powering, charging, and connectivity in both professional and personal environments.

- Seamless Access
- Comprehensive Charging Options
- Versatile Connectivity
- Customizable Sizes Available

## Configuration

2 Universal 6/13 Ampere Or  
Indian 6 Ampere Power Socket  
1 USB A + C  
1 RJ-45 (CAT 6)  
1 HDMI (4K)  
Finish Colors : Black & Silver  
Pre Wired 300mm with Screwless Connector

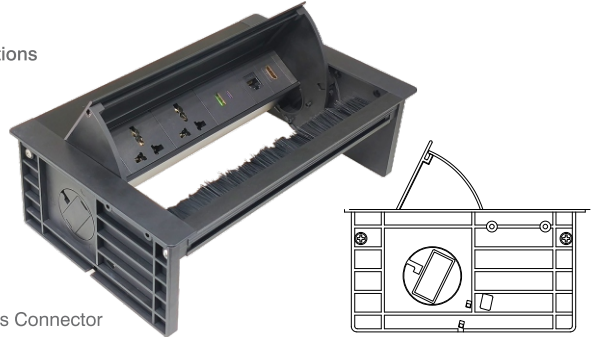

# Aero Flip With GST Connector

The MX Aero flip is a sophisticated and versatile solution designed to streamline workspace power and connectivity needs. With a simple press, its flap opens seamlessly to reveal an array of features, including 2 universal or Indian sockets, USB-A and USB-C ports supporting 12W to 30W charging with GaN technology, RJ-45 (CAT-6), and HDMI 4K connectivity. Additionally, it includes GST connectors for easy integration with modular furniture systems. This innovative unit is ideal for efficient powering, charging, and connectivity in both professional and personal environments.

- GST connectors
- Seamless Access
- Versatile Connectivity
- Customizable Sizes Available

## Configuration

2 Universal 6/13 Ampere Or  
Indian 6 Ampere Power Socket  
1 USB A + C  
1 RJ-45 (CAT 6)  
1 HDMI (4K)  
Finish Colors : Black & Silver

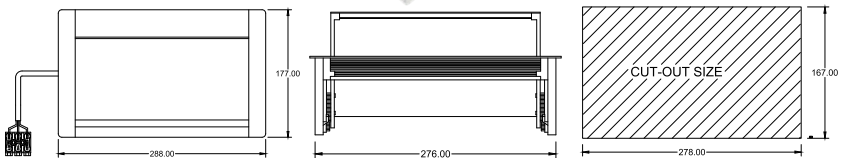
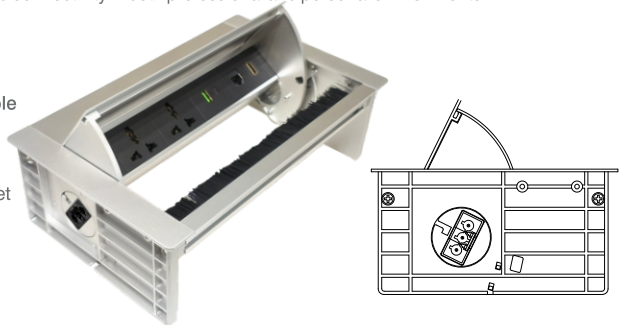

MX No.	Universal or Indian Socket	USB A+C	HDMI 4K	RJ-45 Cat 6	GST Connector	Silver or Black
7103	2	1	1	1	-	Yes
7104	2	1	1	1	1	Yes

## Customized Multimedia & Sockets on Request :

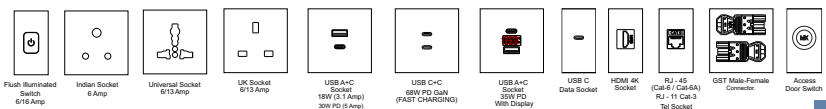



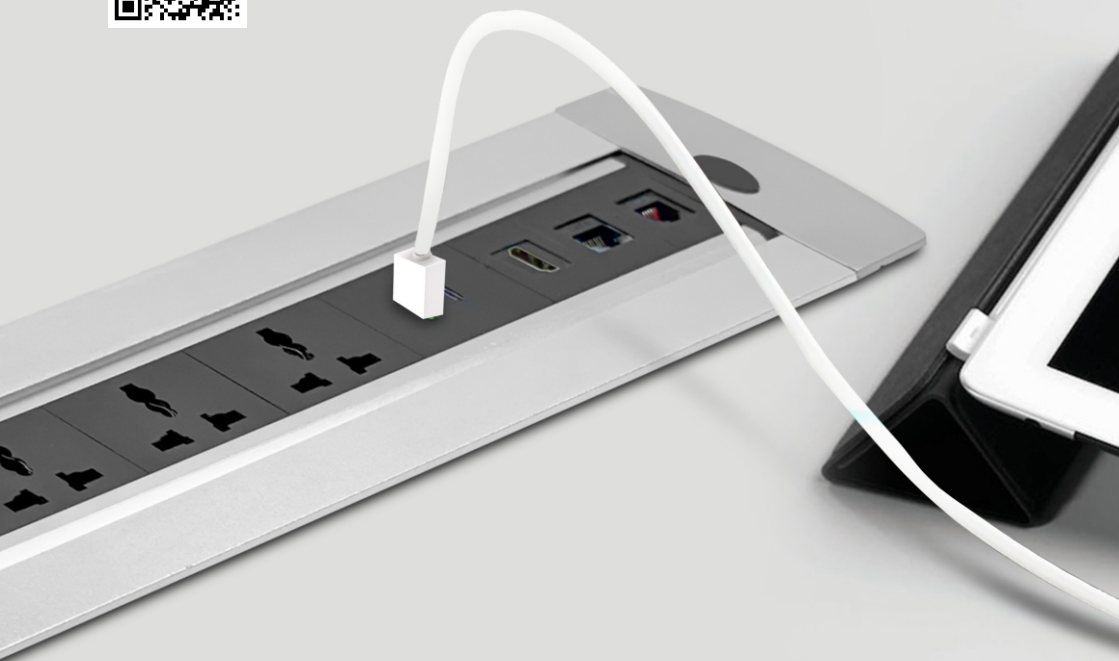

# Comfort Turn Pop-up

The MX Comfort turn pop-up box features a rotating design, activated by a hidden button, allowing you to easily reveal or conceal the socket outlets. When closed, it sits flush with the surface, offering an unobtrusive look when not in use. This design simplifies installation and enhances functionality, particularly in conference and boardroom tables. Crafted from durable aluminum alloy, it includes 2 universal or Indian sockets, USB-A and USB-C ports (12W to 30W charging, GaN support), RJ-45 (CAT-6), HDMI 4K connectivity, and 2 customizable blank plates. An integrated 6 Amp switch adds convenience, making it ideal for powering, charging, and connecting in both professional and personal spaces.

- Effortless Operation
- Comprehensive Connectivity
- Durable Design
- Customizable Sizes Available

## Configuration

- 2 Universal 6/13 Ampere or Indian 6 Ampere Power Socket
- 1 USB A + C
- 1 RJ-45 (CAT 6)
- 1 HDMI (4K)
- 2 Blank Plate
- Switch 6 Ampere
- Pre Wired 300 mm Screwless Connector

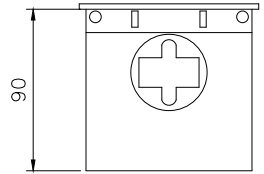

# Comfort Turn Pop-up With GST Connector

The MX Comfort turn pop-up box features a rotating design, activated by a hidden button, allowing you to easily reveal or conceal the socket outlets. When closed, it sits flush with the surface, offering an unobtrusive look when not in use. This design simplifies installation and enhances functionality, particularly in conference and boardroom tables. Crafted from durable aluminum alloy, it includes 2 universal or Indian sockets, USB-A and USB-C ports (12W to 30W charging, GaN support), RJ-45 (CAT-6), HDMI 4K connectivity, and 2 customizable blank plates. An integrated 6 Amp switch adds convenience, making it ideal for powering, charging, and connecting in both professional and personal spaces.

- GST connectors
- Effortless Operation
- Comprehensive Connectivity
- Customizable Sizes Available

## Configuration

- 2 UNIVERSAL 6/13 Ampere or Indian 6 Ampere Power Socket
- 1 USB A + C
- 1 RJ-45 (CAT 6)
- 1 HDMI (4K)
- 2 Blank Plate
- Switch 6 Ampere

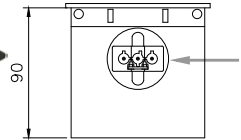

GST Connector

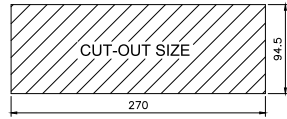
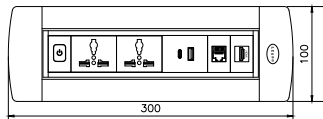
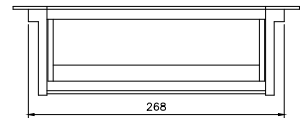

MX No.	Universal or Indian Socket	USB A+C	HDMI 4K	RJ-45 Cat 6	GST Connector	Silver or Black
7101	2	1	1	1	-	Yes
7102	2	1	1	1	1	Yes

## Customized Multimedia & Sockets on Request :

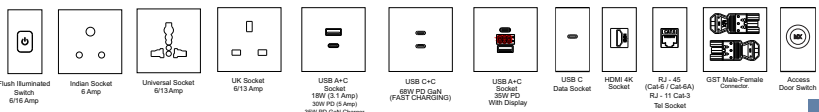



# DUPLEX ACCESS FLAP WITH UNDER DESK CABLE MANAGEMENT TRAY

The Duplex Access flaps are designed for seamless integration and effortless access to power sources. An integrated frame and double-sided cover plate provide convenient dual-sided access, ensuring flexibility in any workspace. The inclusion of buffer-damping technology enables silent opening and closing, preserving a calm and focused environment. Compatible with integrated and bottom box configurations, these flaps are versatile and well-suited for various applications, including workstations, meeting tables, conference tables, executive desks, and classroom furniture.

- Dual-Sided Access
- Silent Operation
- Versatile Compatibility
- Customizable Sizes Available

Allow Access To Power & Data  
From Both Side  
Finish Colors : Black & White

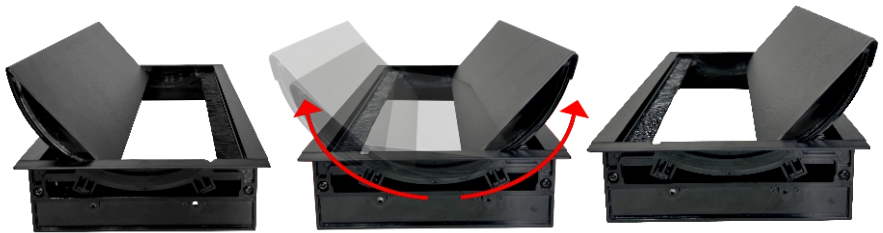
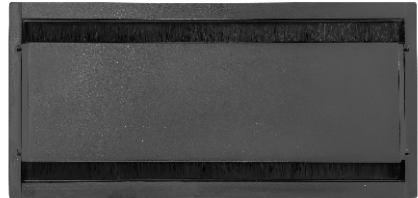

- MX 7107 - 300 mm
- MX 7107A - 450 mm
- MX 7107B - 600 mm

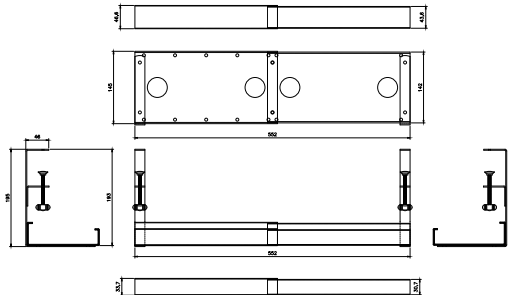
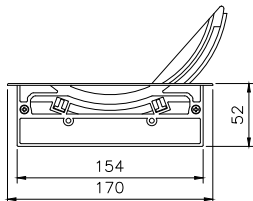
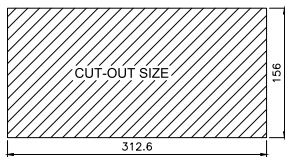
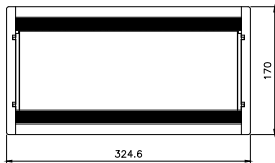



# MX Cable Cubby Box

The MX Cable Cubby is ideal for furniture AV connectivity, power, and cable management. These durable, furniture-mountable enclosures integrate seamlessly with any décor and are easy to install, with many featuring a tool-free clamp system. They support MX Cable Cubby Retractor Series retraction modules and offer an optional wireless charging feature for efficient device powering. It is fully customizable in sockets and ports and is perfect for boardrooms, classrooms, and collaborative spaces. Its sleek, clutter-free design ensures easy access to power, data, and AV connections, promoting a streamlined and organized workspace.

- Effortless Access
- Flexible Customization
- Versatile Integration
- Optional Wireless Charging

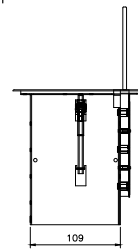
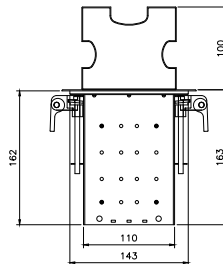
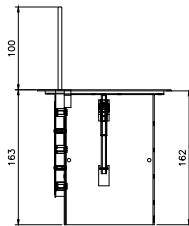
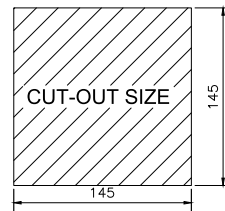
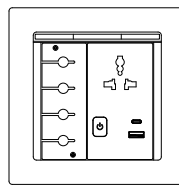
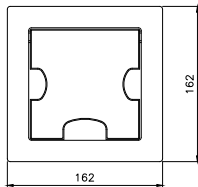
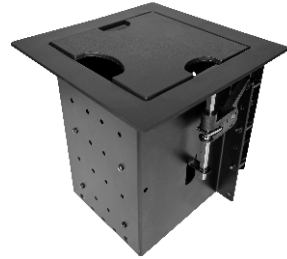

MX No.	Universal or Indian Socket	USB A+C 30 W PD	HDMI or Cat-6	PASS THROUGH	WIRELESS CHARGING
CC 500	2	-	-	1	-
CC 501	1	1	-	1	-
CC 501 Qi	1	1	-	1	1
CC 502	2	1	1	-	-
CC 502 Qi	2	1	1	-	1

## Customized Multimedia & Sockets on Request :

Flush Illuminated Switch 6/16 Amp	Indian Socket 6 Amp	Universal Socket 6/13 Amp	Universal Socket 6/13 Amp 180 Rotated	UK Socket 6/13 Amp	USB A+C Sockets 18W (3.1 Amp) 30W PD (5 Amp) 35W PD GaN Charger	USB C+C 65W PD GaN (FAST CHARGING)	USB C Data Socket	HDMI 4K Socket	RJ-45 (Cat-6 / Cat-6A) RJ-11 Cat-3 Tel Socket

# MX Cable Cubby Box

The MX Cable Cubby is ideal for furniture AV connectivity, power, and cable management. These durable, furniture-mountable enclosures integrate seamlessly with any décor and are easy to install, with many featuring a tool-free clamp system. They support MX Cable Cubby Retractor Series retraction modules and offer an optional wireless charging feature for efficient device powering. It is fully customizable in sockets and ports and is perfect for boardrooms, classrooms, and collaborative spaces. Its sleek, clutter-free design ensures easy access to power, data, and AV connections, promoting a streamlined and organized workspace.

- Effortless Access
- Flexible Customization
- Versatile Integration
- Optional Wireless Charging

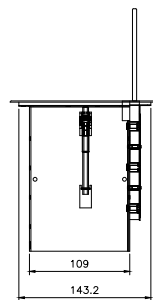
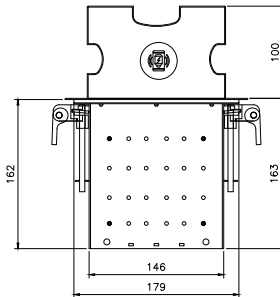
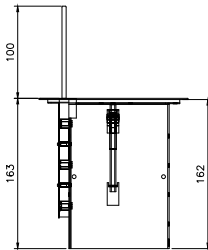
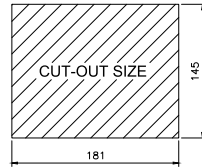
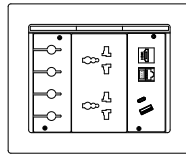
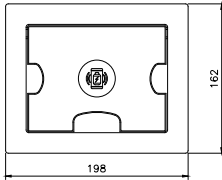

MX No.	Universal or Indian Socket	USB A+C 30 W PD	HDMI or Cat-6	PASS THROUGH	WIRELESS CHARGING
CC 700	2	-	-	2	-
CC 701	2	1	1	1	-
CC 701 Qi	2	1	1	1	1
CC 702	1	2	1	1	-
CC 702 Qi	1	2	1	1	1

## Customized Multimedia & Sockets on Request :



Flush Illuminated Switch  
6/16 Amp



Indian Socket  
6 Amp



Universal Socket  
6/13 Amp



Universal Socket  
6/13 Amp  
180 Retard



UK Socket  
6/13 Amp



USB A+C Socket  
18W (3.1 Amp)  
30W PD (3-Amp)  
36W PD GAN Charger



USB C-C  
65W PD GAN  
(FAST CHARGING)



USB C Data Socket



HDMI 4K Socket



RJ-45 (Cat-6/Cat-6A)  
RJ-11 Cat-3 Tel Socket

# MX Cable Cubby Retractor

The MX Cable Retractor with cable-speed Control is an innovative solution designed to enhance AV and workspace management with efficiency and elegance. Compatible with Cable Cubby, it offers high-performance cables, including HDMI 4K, RJ-45 (CAT 6), and USB-C (8K & PD 100W) for power and data transfer. The retractor features a user-friendly speed control mechanism, allowing cables to retract easily at the press of a button, keeping your workspace neat and clutter-free.



- Effortless Cable Management
- Versatile Connectivity
- Easy Control



**MX 8000**  
HDMI 4K Cable  
3.75 Meter



**MX 8001**  
RJ-45 (CAT 6) Cable  
3.75 Meter



**MX 8002**  
USB C For Data & Power  
(8K & 100W) Cable, 3.75 Meter

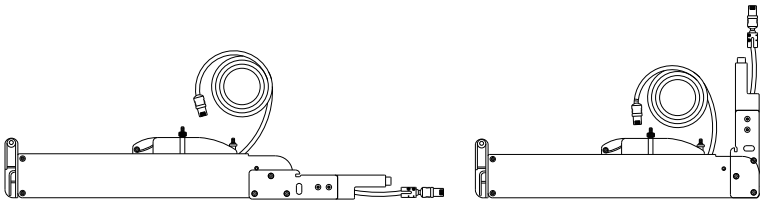

CAN BE INSTALLED VERTICALLY OR HORIZONTALLY UNDER TABLE



**MX 8003**  
Flip Up With Cable Retractor  
1 HDMI (4K) + 1 RJ-45 (CAT 6)  
1 USB C (8K & 100W)



**MX 8004**  
Retractor Filler  
With Pass Through



**MX 8005**  
Retractor C Bracket  
With Screw



# MX Wing Cable Guide

The MX Wing is an innovative solution designed for easy installation of power connections in any standard kitchen drawer, providing secure cable management and preventing cables from becoming jammed or damaged. By utilizing the space behind the drawer, it frees up valuable work surface area. The Wing supports both wooden and metal drawer back panels, offering two cable guide options—clamping or screwing—ensuring compatibility with various cable types, including HDMI, LAN, and power cables. As a built-in solution, the Wing is discreetly positioned behind any drawer or pull-out shelf. Its articulated arm can be mounted in multiple orientations (left, right, horizontally, or vertically), providing flexible installation in any part of the furniture.



**MX 7100**

SECURE & EFFICIENT CABLE MANAGEMENT FOR FURNITURE

- Secure Cable Management
- Versatile Mounting Options
- Efficient Space Utilization
- Multi-Purpose Design:

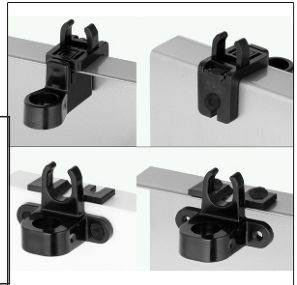
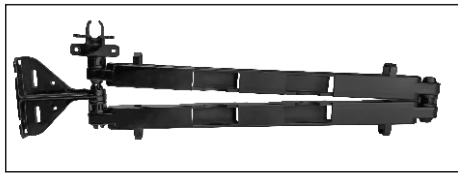

**BACK SIDE**

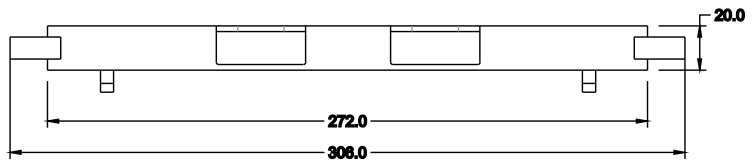

**BOTTOM SIDE**

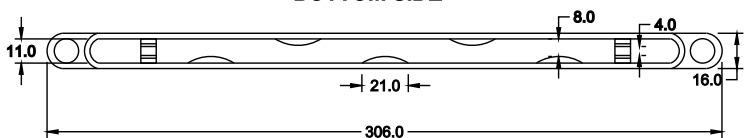



# Docksquare

The MX Docksquare is thoughtfully engineered to streamline installation and enhance functionality in study tables and office workstations. Featuring BIS-approved sockets, it enables seamless connectivity and efficiently consolidates essential workplace connections within easy reach on the desktop. The unit includes 2 universal or Indian BIS-approved sockets, USB-A and USB-C ports with 12W to 30W charging and GaN support, RJ-45 (CAT-6), and HDMI 4K connectivity, along with a 6 Amp dual-pole switch and screwless connectors. This versatile solution is ideal for powering, charging, and connecting devices in both professional and personal environments.

- Compact & Convenient
- Versatile Compatibility
- Enhanced Safety & Efficiency
- Customizable Sizes Available

## Configuration

2 UNIVERSAL 6/13 Ampere or  
Indian 6 Ampere Power Socket  
1 USB A + C  
1 RJ-45 (CAT 6)  
1 HDMI (4K)  
Dual Pole Switch 6 Ampere  
Finish Colors : Black & Grey

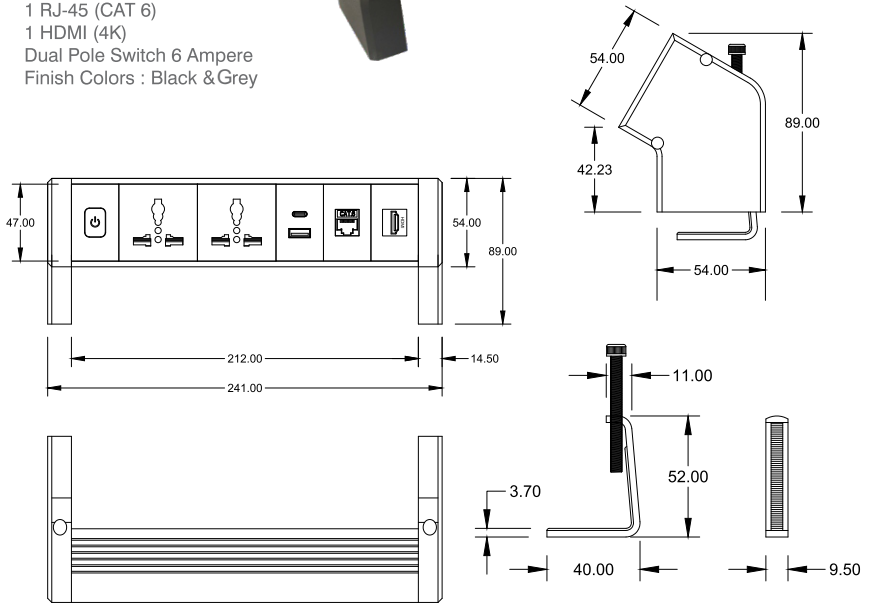

MX No.	Indian or Universal Socket	Indian Standard Socket 6/16 Amp	USB A + C	CAT 6	HDMI 4K	Black or Grey	Dimensions (mm)
7108	2	-	1	1	1	Yes	241 x 89
7109	-	2	1	1	1	Yes	

## Customized Multimedia & Sockets on Request :

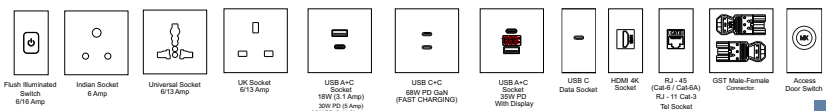

# Desktop Motorized Turn Pop Up

Motorized Turn Plug & Play Pop-Up Boxes revolutionize conference and boardroom tables with their quick and simple installation process. Pre-wired patch-in and patch-out cables make connectivity a breeze, while the motorized function offers convenient panel opening and closing. Break beam sensors ensure safety by preventing accidental closure while the product is in use. Crafted from sleek aluminum alloy, these pop-up boxes seamlessly integrate into your meeting space aesthetic.

## SPECIFICATION

- Rated Voltage : 250V~ Single-phase
- Rated Current : 6-13 Amperes (Max)
- USB Charger : Type A&C Ports 18W
- Material : Aluminum, Polycarbonate
- Finish Colors : Silver & Black (Anodized)
- Wiring : 3 x 1 mm<sup>2</sup> Cable 1.5 meter with 6 Amps PI
- Multimedia : Pre-connected Cable
- Standard Pack : Mounting Hardware
- Sensor for protection

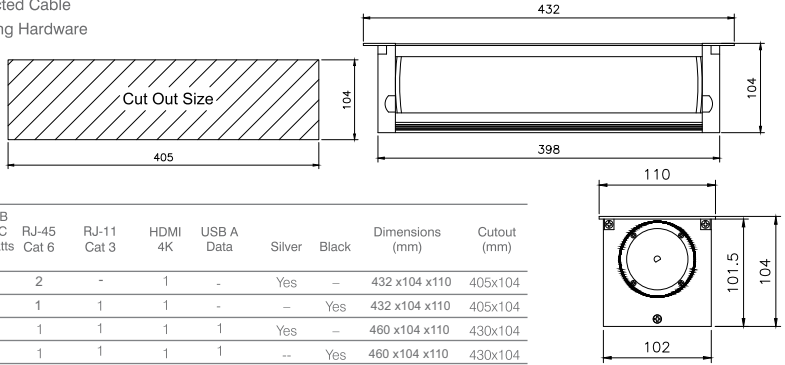

MX No.	Universal Socket 6/13 Amperes	2 USB A + C 18 Watts	RJ-45 Cat 6	RJ-11 Cat 3	HDMI 4K	USB A Data	Finish		Dimensions (mm)	Cutout (mm)
							Silver	Black		
7000	3	1	2	-	1	-	Yes	-	432 x104 x110	405x104
7000A (Black)	3	1	1	1	1	-	-	Yes	432 x104 x110	405x104
7000B	3	1	1	1	1	1	Yes	-	460 x104 x110	430x104
7000C (Black)	3	1	1	1	1	1	-	Yes	460 x104 x110	430x104

# Motorized Turn Meld Wireless

Motorized Turn melded wireless Plug & Play Pop-Up Boxes represent a unique innovation for conference and boardroom tables, offering both quick and simple installation and a seamless blend of wired and wireless charging capabilities. Pre-wired patch-in and patch-out cables ensure effortless connectivity, while the motorized function allows for convenient panel opening and closing. Qi-compatible wireless charging ensures compatibility with all your devices, eliminating the need for unsightly cables. Break beam sensors provide an extra layer of safety by preventing accidental closure during use. Crafted from sleek aluminum alloy, these pop-up boxes integrate seamlessly into your meeting space, maintaining a modern and professional aesthetic.

## SPECIFICATION

- Mx Artical No.: 7000 D (Silver) / 7000 E (Black)
- Rated Voltage : 250V~ Single-phase
- Rated Current : 6-13 Amperes (Max)
- USB Charger : Type A&C Ports 18W
- Wireless Charger : 15 Watts
- Material : Aluminium, Polycarbonate
- Finish Colors : Silver & Black
- Wiring : 3 x 1 mm<sup>2</sup> Cable 1.5 meter with 6 Amps Plug.
- Multimedia : Pre-connected cables
- Standard pack : Mounting Hardware Sensor for protection

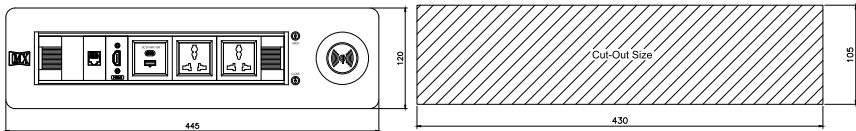

MX No.	Universal Socket 6/13 Amperes	2 USB A + C 18 Watts	Data Cat	HDMI 4K	Dimensions (mm)	Cutout (mm)	Finish	
							Silver	Black
7000D	2	1	1	1	445X120X100	430X105	Yes	-
7000E	2	1	1	1	445X120X100	430X105	-	Yes

# Desktop Manual Turn Pop Up

Manual Plug & Play Pop-Up Boxes simplify installation in conference and boardroom tables. Pre-wired patch-in and patch-out cables ensure effortless connectivity, while the simple turnaround function allows for convenient panel opening and closing. Constructed of durable aluminum alloy, these pop-up boxes seamlessly integrate into your meeting space, offering a modern and functional solution.

## SPECIFICATION

Rated Voltage : 250V~

Rated Current : 6-13Amps (Max)

USB Charger : Type A & C Ports 18W

Material : Aluminum, Polycarbonate

Finish Colors : Silver & Black (Anodized)

Wiring : 3 x 1 mm<sup>2</sup> Cable 1.5 meter with 6 Amps Plug.

Multimedia : Pre-connected cables

Standard Pack : Mounting Hardware

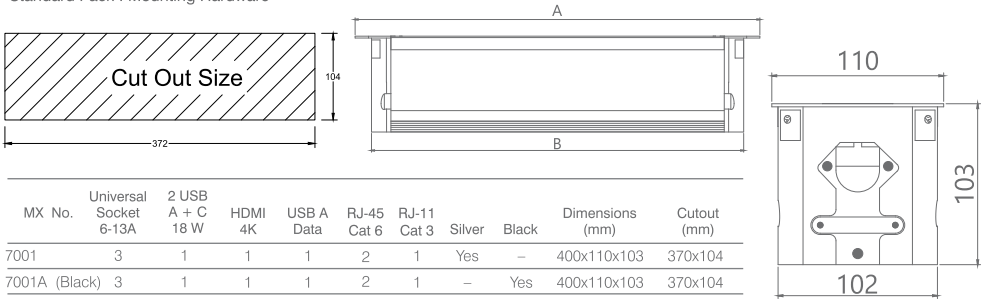

# Hydraulic Pop Up

Hydraulic Plug & Play Pop-Up Boxes facilitate quick and simple installation with pre-wired patch-in and patch-out cables for effortless connectivity. A convenient press button function allows for easy panel opening and closing, while the sleek aluminum alloy construction seamlessly integrates into conference and small meeting room tables.

## SPECIFICATION

Rated Voltage : 250V~

Rated Current : 6-13Amps (Max)

Material : Aluminium, Polycarbonate

Finish Colors : Silver & Black (Anodized)

Wiring : 3 x 1 mm<sup>2</sup> Cable 1.5 meter with 6 Amps Plug.

Multimedia : Pre-connected cables

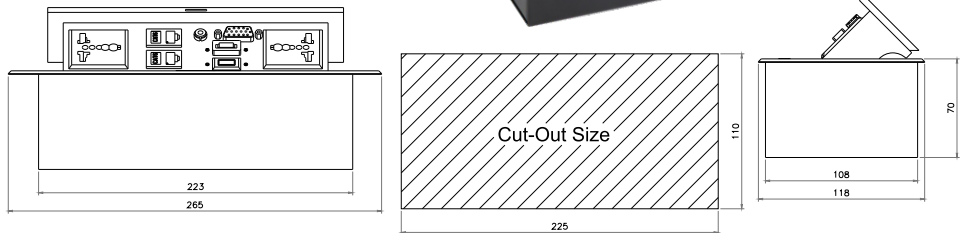



# Access Flaps

The Access flaps offer seamless integration and convenient access to power sources. Featuring an integral frame and cover plate, these flaps provide single or dual-sided access to outlets, ensuring flexibility in your workspace. Additionally, buffer damping ensures silent opening and closing, maintaining a peaceful environment. These flaps are compatible with both integrated and bottom box configurations, making them suitable for a wide range of applications, including workstations, meeting room tables, conference tables, executive tables, and even classroom desks.



ACCESS FLAP WITH GASKET  
7019 / 7023 / 7027

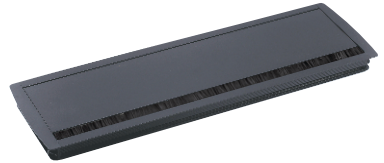

ACCESS FLAP WITH BRUSH  
7020 / 7024 / 7028



ACCESS FLAP WITH BRUSH  
1 USB A + 1 USB C 12 / 18 / 30W PD  
7022 / 7026 / 7030



ACCESS FLAP WITH GASKET  
1 USB A + 1 USB C 12 / 18 / 30W PD  
7021 / 7025 / 7029

MX No.	Gasket	Brush	USB A+C	AL	Size (mm)	Dimensions With End Cap (mm)	Cutout (mm)
7019	Yes	-	-	Yes	300 mm	334 X 150 X 28	316 X 134
7020	-	Yes	-	Yes	300 mm	347 X 150 X 28	316 X 134
7021	Yes	-	Yes	Yes	300 mm	347 X 150 X 28	330 X 134
7022	-	Yes	Yes	Yes	300 mm	485 X 150 X 28	330 X 134
7023	Yes	-	-	Yes	450 mm	485 X 150 X 28	466 X 134
7024	-	Yes	-	Yes	450 mm	485 X 150 X 28	466 X 134
7025	Yes	-	Yes	Yes	450 mm	497 X 150 X 28	480 X 134
7026	-	Yes	Yes	Yes	450 mm	497 X 150 X 28	480 X 134
7027	Yes	-	-	Yes	600 mm	640 X 150 X 28	616 X 134
7028	-	Yes	-	Yes	600 mm	640 X 150 X 28	616 X 134
7029	Yes	-	Yes	Yes	600 mm	650 X 150 X 28	630 X 134
7030	--	Yes	Yes	Yes	600 mm	650 X 150 X 28	630 X 134

## Customized Multimedia & Sockets on Request :



USB A+C  
SOCKET  
12W (2,4Amp)  
18W (3,1Amp)  
30 W PD (5Amp)  
35 W PD GaN Charger

# Access Flaps

The Access flap features an integrated frame and soft closure, offering single-sided access to an electrical outlet while seamlessly blending into your workspace. Its compatibility with an integrated bottom box provides additional flexibility, and USB charging ports conveniently located on the side cap ensure effortless charging for your electronic devices. This versatile flap is ideal for various applications, including workstations, meeting room tables, conference tables, supervisor desks, and even classroom desks, enhancing functionality and accessibility in any environment.



ACCESS FLAP SINGLE SOFT CLOSE  
7003 / 7003 A / 7003 B  
7004 / 7004 A / 7004 B



ACCESS FLAP PC  
7007 / 7007 A / 7007 B



ACCESS FLAP DOUBLE  
7006 / 7006 A

MX No.	Soft Close	AL	PC	Silver	Black	White	Size	Dimensions (mm)	Cutout (mm)
7003	Yes	Yes	--	Yes	--	--	300 mm	300 x 127 x 30	290 x 110
7003 A	Yes	Yes	--	--	Yes	--	300 mm	300 x 127 x 30	290 x 110
7003 B	Yes	Yes	--	--	--	Yes	300 mm	300 x 127 x 30	290 x 110
7004	Yes	Yes	--	Yes	--	--	450 mm	450 x 127 x 30	440 x 110
7004 A	Yes	Yes	--	--	Yes	--	450 mm	450 x 127 x 30	440 x 110
7004 B	Yes	Yes	--	--	--	Yes	450 mm	450 x 127 x 30	440 x 110
7006	--	Yes	--	Yes	--	--	300 mm	300 x 127 x 30	290 x 110
7006 A	--	Yes	--	Yes	--	--	450 mm	450 x 127 x 30	440x 110
7007	--	--	Yes	Yes	--	--	300 mm	300 x 127 x 30	290 x 110
7007 A	--	--	Yes	--	Yes	--	300 mm	300 x 127 x 30	290 x 110
7007 B	--	--	Yes	--	--	Yes	300 mm	300 x 127 x 30	290 x 110

MX-7003/A/B

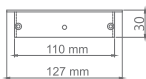

MX-7006A



MX-7004/A/B

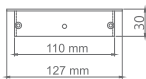
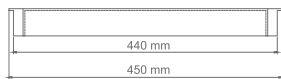

MX-7007/A/B

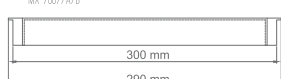

MX-7006

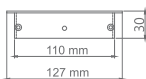
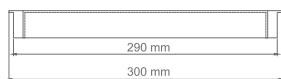



# CABLE ORGANISER & CABLE MANAGEMENT

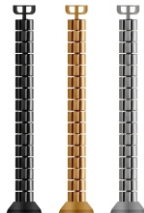

## DESIGNER CABLE ORGANIZER

MX 2762 - 4 WAY

MX 2763 - 6 WAY

MX 2764 - 8 WAY

Finish Colors : Black, Silver, Rose Gold  
Length : 0.76 Mtrs (16 Pcs)

## PROFESSIONAL CABLE ORGANIZER

MX 2696

Finish Colors : Black, Gray, Ivory

Length : 1.5 Mtrs to 50Mtrs



## ROBOT CABLE ORGANIZER

MX 2816

Finish Colors : Black, Gray, Ivory  
Length : 75 CMS (48 Pcs)

MX 2817

T Type 3 Way Cable Organizer  
Finish Colors : Black & Gray

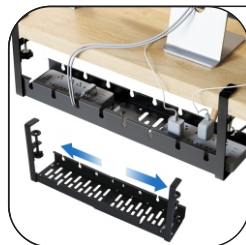

## UNDER DESK CABLE MANAGEMENT TRAY

Finish Colors : Black  
Length : 0.28 to 1.5 Meters

# PROTECT + CONNECT



## MX-PD1604 Features

The MX-PD1604 is a compact, network-enabled PDU with 4 individually switchable IEC C13 outlets (max 10A total) designed for AV and IT environments. It features high-inrush relays (30A/4s, 80A/20ms), integrated metering (voltage, current, power, energy), and Type 3 surge protection, EMI Filter, Inrush Current Protection using Zero crossing Technology.

<b>Outputs:</b> 4x IEC C13 (individually switchable)
<b>Max Current:</b> 16 A total, 10 A per port
<b>Input/Output Voltage:</b> 90V -300 V AC 50Hz/60Hz
<b>Protection:</b> Type 3 surge protection (max. L-N, N/L-PE 10 kA) EMI Filter (blocks unwanted electromagnetic interference) Inrush Current Protection using Zero crossing Technology Individual Short circuit Protection
<b>Metering:</b> Voltage (V), Current (A), Frequency (Hz), Active/Reactive/Apparent Power (W/Var/VA), Power Factor (PF), Energy (kWh)
<b>Network Protocols:</b> HTTP, WiFi
<b>Sensor Input:</b> 1x RJ45 for plug-and-play sensors (temperature, humidity, air pressure).
<b>High-Inrush Relay:</b> Handles up to 80 A for 20ms, making it suitable for high-surge loads.
<b>Display:</b> On Unit LCD Display for online monitoring and setting port Output.
<b>Cascading:</b> Allows to cascade multiple (up to 10) PDU units through Rj45 for Monitoring and controlling all units on singl GUI.
<b>Mounting:</b> Compact, can be mounted behind displays
<b>Dimension:</b> 255mm x 45mm x 125mm LxHxD

## Web Page Features

<b>Monitoring:</b>	Individual channels Voltage, Current, Power can be monitored on Webpage and also on PDU Units LCD display  Each channle can be Switched ON/OFF through Webpage and also on PDU Unit  Log report of input Voltage, Input Current, Input Power is generated of past 24 hrs. To monitor performance, and helps in troubleshooting in case of failure
<b>Sequencer :</b>	Each channel can be programed to Switch ON/switch OFF in sequence one afteranother at pre defined delays, to manage the order and timing of power delivery to connected equipment, which enhances system saftey, stability, and reliability.
<b>Schedule:</b>	Each channel can be programed to switch ON/switch OFF at pre defined timing every day/ every week.
<b>Alarm:</b>	Each channels working voltage limits (minimumVoltage maximum voltage max Curent) can be configured byond which PDU will Switch Off that channel to avoid hazardous condition.
	Sensors like Temperature and Humidity can be configure to Switch ON and Switch OFF any one channel or all channels

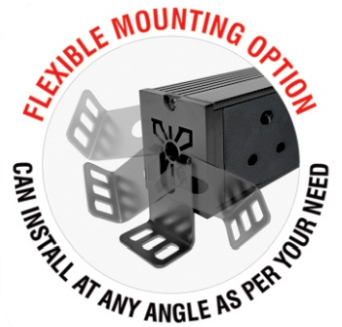

# Versatile Power Distribution Unit (PDU)

[ ALUMINUM EXTRUSION BODY ]



**MX 4248**



**MX 4261**

MX No.	No. of Outlet	Indian Socket 6 AMP / Universal Socket 6/13 AMP	Standard Indian Socket 16 AMP	Switch Type	Fuse	Length
MX 4238	2	Yes	-	Flush Mount	-	147 mm / 5.7"
MX 4239	3	Yes	-	Flush Mount	-	195 mm / 7.6"
MX 4240	4	Yes	-	Flush Mount	-	243 mm / 9.5"
MX 4241	5	Yes	-	Flush Mount	-	291 mm / 11.4"
MX 4242	6	Yes	-	Flush Mount	-	339 mm / 13.3"
MX 4243	7	Yes	-	Flush Mount	-	435 mm / 17.1"
MX 4244	2	-	Yes	Flush Mount	-	159 mm / 6.2"
MX 4245	3	-	Yes	Flush Mount	-	213 mm / 8.3"
MX 4246	4	-	Yes	Flush Mount	-	267 mm / 10.5"
MX 4247	5	-	Yes	Flush Mount	-	321 mm / 12.6"
MX 4248	6	-	Yes	Flush Mount	-	375 mm / 14.7"
MX 4249	7	-	Yes	Flush Mount	-	483 mm / 19"
MX 4250	2	Yes	-	LED Indicator 6 Amp	Yes	195 mm / 7.6"
MX 4251	3	Yes	-	LED Indicator 6 Amp	Yes	242 mm / 9.5"
MX 4252	4	Yes	-	LED Indicator 6 Amp	Yes	289 mm / 11.3"
MX 4253	5	Yes	-	LED Indicator 6 Amp	Yes	336 mm / 13.2"
MX 4254	6	Yes	-	LED Indicator 6 Amp	Yes	383 mm / 15"
MX 4255	7	Yes	-	LED Indicator 6 Amp	Yes	477 mm / 18.7"
MX 4256	2	-	Yes	LED Indicator 16 Amp	Yes	215.88 mm / 8.4"
MX 4257	3	-	Yes	LED Indicator 16 Amp	Yes	262.98 mm / 10.3"
MX 4258	4	-	Yes	LED Indicator 16 Amp	Yes	309.97 mm / 12.2"
MX 4259	5	-	Yes	LED Indicator 16 Amp	Yes	356.97 mm / 14"
MX 4260	6	-	Yes	LED Indicator 16 Amp	Yes	403.97 mm / 15.9"
MX 4261	7	-	Yes	LED Indicator 16 Amp	Yes	497.96 mm / 19.6"

## Customized Multimedia & Sockets on Request :

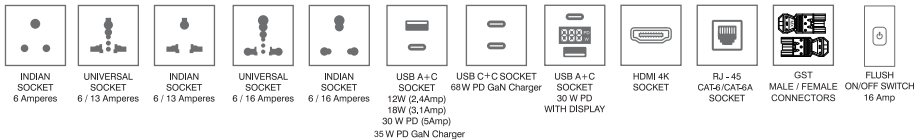

## TRANSPARENT PROTECTIVE WINDOW COVER FOR MCB

**MX 7571E**



2way Transparent protective window cover for MCB 49.4x78.4mm  
Material: PC/ABS Flame Retardant

**MX 7572E**



4way Transparent protective window cover for MCB 91.5x93.2mm  
Material: PC/ABS Flame Retardant

**MX 7573E**



6way Transparent protective window cover for MCB 127x95mm  
Material: PC/ABS Flame Retardant

**MX 7574E**



8way Transparent protective window cover for MCB 163x95mm  
Material: PC/ABS Flame Retardant

**MX 7575E**



12way Transparent protective window cover for MCB 235x95mm  
Material: PC/ABS Flame Retardant

**MX 7576E**



13way Transparent protective window cover for MCB 255x98mm  
Material: PC/ABS Flame Retardant

**MX 7577E**



16way Transparent protective window cover for MCB 309x125mm  
Material: PC/ABS Flame Retardant

## IP66 WATER PROOF SOCKET BOX

**MX 7578**



**MX IP66 WATERPROOF ELECTRICAL OUTDOOR SOCKET BOX, DUSTPROOF 250V 16A - 2 MODULE WITH LOCKING SYSTEM**

Waterproof	IP66 Rating
Rated Voltage	6-13A / 250V
Material	PC / ABS
Function	Anti-UV Waterproof
Application	OUTDOOR   GARDEN   HOTELS
Socket Size	2 Module 45x45 mm

**6 / 16 AMPERES FOR MODULAR INDIAN STANDARD, UK, USA, GERMAN SCHUKO, FRENCH & AUDIO SOCKETS**

**MX 7579**



**MX IP66 WATERPROOF ELECTRICAL OUTDOOR SOCKET BOX, DUSTPROOF 250V 16A - 4 MODULE WITH LOCKING SYSTEM**

Waterproof	IP66 Rating
Rated Voltage	6-13A / 250V
Material	PC / ABS
Function	Anti-UV Waterproof
Application	OUTDOOR   GARDEN   HOTELS
Socket Size	4 Module 45x45 mm

**6 / 16 AMPERES FOR MODULAR INDIAN STANDARD, UK, USA, GERMAN SCHUKO, FRENCH & AUDIO SOCKETS**

**MX 7580**



**MX IP66 WATERPROOF ELECTRICAL OUTDOOR SOCKET BOX, DUSTPROOF WITH SPRING OPENING 250V 16A WITH ABS SHELL FOR GARDENS - 2 MODULE WITH LOCKING SYSTEM**

Waterproof	IP66 Rating
Rated Voltage	6-13A / 250V
Material	PC / ABS
Function	Anti-UV Waterproof
Application	OUTDOOR   GARDEN   HOTELS
Socket Size	2 Module 45x45 mm
Type	Spring Opening

**6 / 16 AMPERES FOR MODULAR INDIAN STANDARD, UK, USA, GERMAN SCHUKO, FRENCH & AUDIO SOCKETS**

**MX 7581**



**MX IP66 WATERPROOF ELECTRICAL OUTDOOR SOCKET BOX, DUSTPROOF WITH SPRING OPENING 250V 16A WITH ABS SHELL FOR GARDENS - 4 MODULE**

Waterproof	IP66 Rating
Rated Voltage	6-13A / 250V
Material	PC / ABS
Function	Anti-UV Waterproof
Application	OUTDOOR   GARDEN   HOTELS
Socket Size	4 Module 45x45 mm
Type	Spring Opening

**6 / 16 AMPERES FOR MODULAR INDIAN STANDARD, UK, USA, GERMAN SCHUKO, FRENCH & AUDIO SOCKETS**

**MX 7582**



**MX IP66 WATERPROOF ELECTRICAL OUTDOOR SOCKET BOX, DUSTPROOF WITH SPRING OPENING 250V 16A WITH ABS SHELL FOR GARDENS - 4 MODULE**

Waterproof	IP66 Rating
Rated Voltage	6-13A / 250V
Material	PC / ABS
Function	Anti-UV Waterproof
Application	OUTDOOR   GARDEN   HOTELS
Socket Size	4 Module 45x45 mm
Type	Spring Opening

**6 / 16 AMPERES FOR MODULAR INDIAN STANDARD, UK, USA, GERMAN SCHUKO, FRENCH & AUDIO SOCKETS**

**MX 7583**



**MX IP66 WATERPROOF ELECTRICAL OUTDOOR SOCKET BOX WITH SWITCH, DUSTPROOF WITH SPRING OPENING 250V 16A WITH ABS SHELL FOR FOR OUTDOOR LIGHTING AND ELECTRICAL APPLIANCE - 2 MODULE**

Waterproof	IP66 Rating
Rated Voltage	6-13A / 250V
Material	PC / ABS
Function	Anti-UV Waterproof
Application	OUTDOOR   GARDEN   HOTELS
Socket Size	2 Module 45x45 mm
Type	Spring Opening with Switch

**6 / 16 AMPERES FOR MODULAR INDIAN STANDARD, UK, USA, GERMAN SCHUKO, FRENCH & AUDIO SOCKETS**

**MX 7584**



**MX IP66 WATERPROOF ELECTRICAL OUTDOOR SOCKET BOX ISOLATION SWITCH, DUSTPROOF WITH SPRING OPENING 250V 16A - 2 MODULE**

Waterproof	IP66 Rating
Rated Voltage	6-13A / 250V
Material	PC / ABS
Function	Anti-UV Waterproof
Application	OUTDOOR   GARDEN   HOTELS
Socket Size	2 Module 45x45 mm
Type	Spring Opening with Switch

**6 / 16 AMPERES FOR MODULAR INDIAN STANDARD, UK, USA, GERMAN SCHUKO, FRENCH & AUDIO SOCKETS**

# 45mm x 45mm Power & Data Cubby Module Box

Compatible With all **European** & **UK** Brands



**MX 7008-M** (4 & 6 Module)  
POWER CUBBY FLAP BOX WITH MODULE



**MX 6406-M** (4 & 6 Module)  
FREE STANDING POWER / TOWER POLE WITH MODULE



**MX 6407-M** (4 & 6 Module)  
UNDER DESK CONSOLE WITH MODULE



**MX 7031-M** (4 & 6 Module)  
IN-SURFACE POWER DISTRIBUTION UNIT BOX WITH MODULE



**MX 4173-M** (4 & 6 Module)  
DESKTOP CONSOLE WITH MODULE

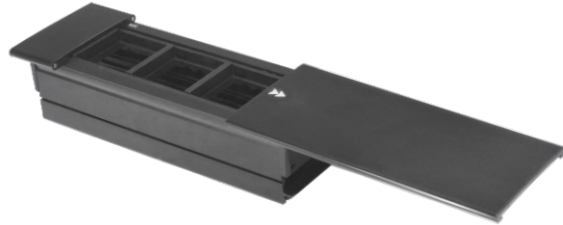

**MX 7005-M** (4 & 6 Module)  
POWER CUBBY SLIDER FLAP WITH MODULE

## Customized Multimedia & Sockets on Request :

Flash Illuminated Switch 6/16 Amp	Indian Socket 8 Amp	Indian Socket 6/16 Amp	Universal Socket 6/13 Amp	Universal Socket 6/13 Amp	UK Socket 6/13 Amp	USB A-C Socket 18W (5.1 Amp) 20W PD (3 Amp) 25W PD GaN Charger	USB C-C Socket 60W PD GaN (FAST CHARGING)	USB A-C Socket 30W PD With Display	USB C Data Socket	HDMI A-C Socket	RJ-45 (Cat-4 / Cat-6A) RJ-11 Cat-3 Tel Socket	GST Male-Female Connector	Acoustic Door Switch



# MX Ceiling Mount Power Post

The MX Ceiling Mount Power Post is a sleek and functional solution for delivering power, data, and communication services directly from the ceiling. Designed to mount only on ceilings, it keeps floor space clear while providing easy accessibility for island workstations, conference tables, and collaborative spaces. Compatible with 45mm x 45mm modules, it allows flexible configurations for sockets, data ports, and multimedia modules. Built with a durable aluminum body and finished in premium powder coating or anodized finish, the MX Ceiling Mount Power Post combines strength, safety, and modern design.

**MX 6418CM**  
(1 Way)

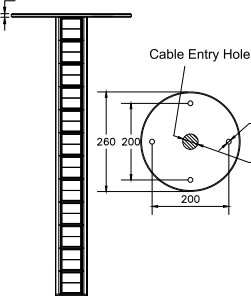

**MX 6419CM**  
(2 Way)

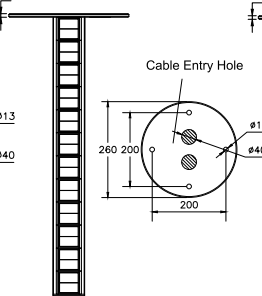

**MX 6420CM**  
(4 Way)

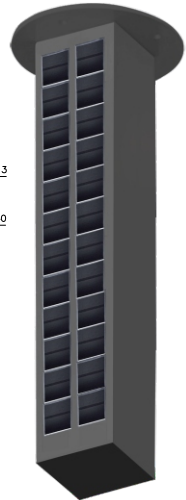
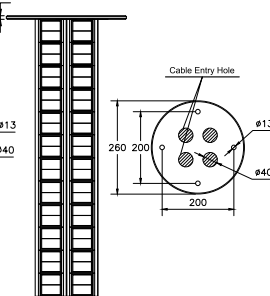

## Customized Multimedia & Sockets on Request :

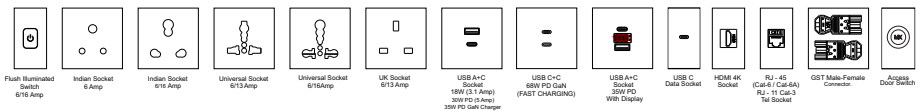



# MX Pop-Up Floor Boxes

The MX Floor Box series pop-up power outlets deliver a safe and innovative solution designed to keep both workspaces and residences functional and clutter-free. Featuring a sleek push-and-slide mechanism that prevents accidental openings, these outlets remain concealed beneath the surface until required, blending seamlessly into any environment. Available in elegant Stainless Steel, Brass, and Aluminum finishes, they enhance aesthetics while offering customizable configurations. Designed with modular flexibility for Type 45 series sockets, they are suitable for versatile use across offices, kitchen counter tops, wood, or concrete floors. Easy to install and built for modern convenience, they redefine how power access integrates into everyday spaces.

## SPECIFICATION

Module Capacity: 3 (Without Modules)  
 Material: **Stainless Steel**  
 Module Type: 45 Series  
 Opening Mechanism: Push & Slide Locking System  
 Opening Type: Soft Opening Pop Up Type  
 Color: Silver  
 Application: For Concrete Floors



### • MX 7200

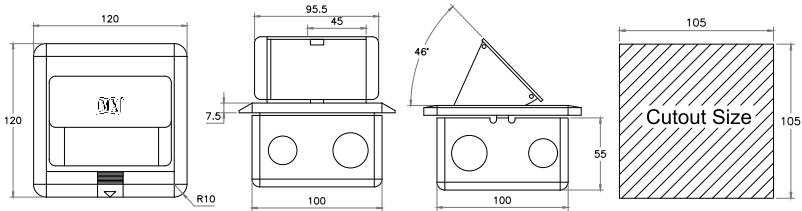

## SPECIFICATION

Module Capacity: 4 (Without Modules)  
 Material: **Aluminium**  
 Module Type: 45 Series  
 Opening Mechanism: Push & Slide Locking System  
 Opening Type: Soft Opening Pop Up Type  
 Color: Silver  
 Application: For Concrete Floors



### • MX 7201

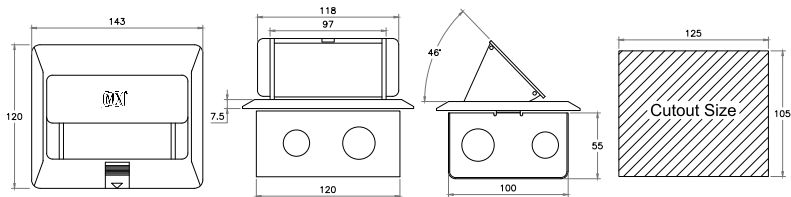

## Customized Multimedia & Sockets on Request :

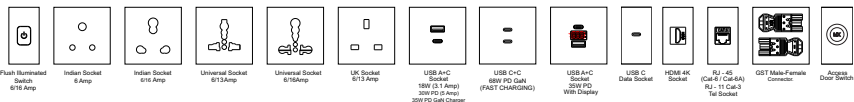

## SPECIFICATION

Module Capacity: 3 (Without Modules)  
 Material: **Aluminium**  
 Module Type: 45 Series  
 Opening Mechanism: Push & Slide Locking System  
 Opening Type: Soft Opening Pop Up Type  
 Color: Silver  
 Application: For Concrete Floors



### • MX 7204

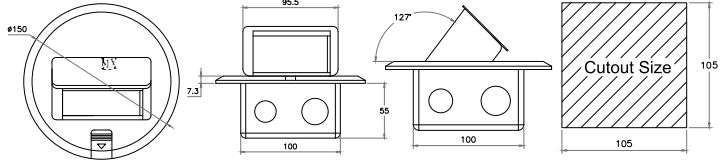

## SPECIFICATION

Module Capacity: 6 [2X3] (Without Modules)  
 Material: **Aluminium**  
 Module Type: 45 Series  
 Opening Mechanism: Push & Slide Locking System  
 Opening Type: Soft Opening Pop Up Type  
 Color: Silver  
 Application: For Concrete Floors



### • MX 7202

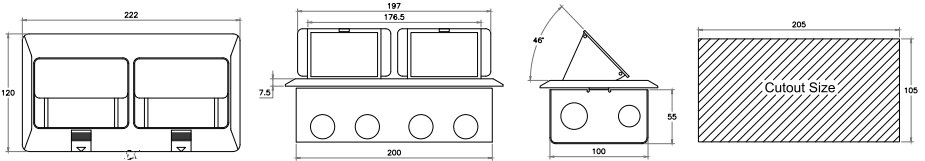

## SPECIFICATION

Module Capacity: 8 [2X4] (Without Modules)  
 Material: **Brass**  
 Module Type: 45 Series  
 Opening Mechanism: Push & Slide Locking System  
 Opening Type: Soft Opening Pop Up Type  
 Color: Brushed Brass  
 Application: For Concrete Floors



### • MX 7203

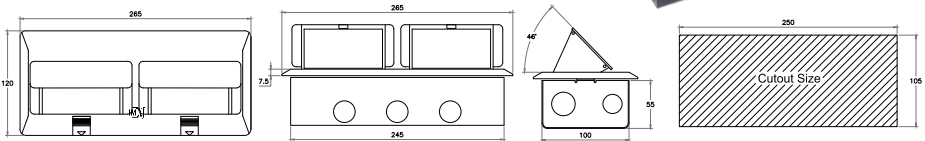

## Customized Multimedia & Sockets on Request :

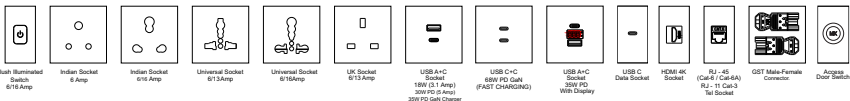

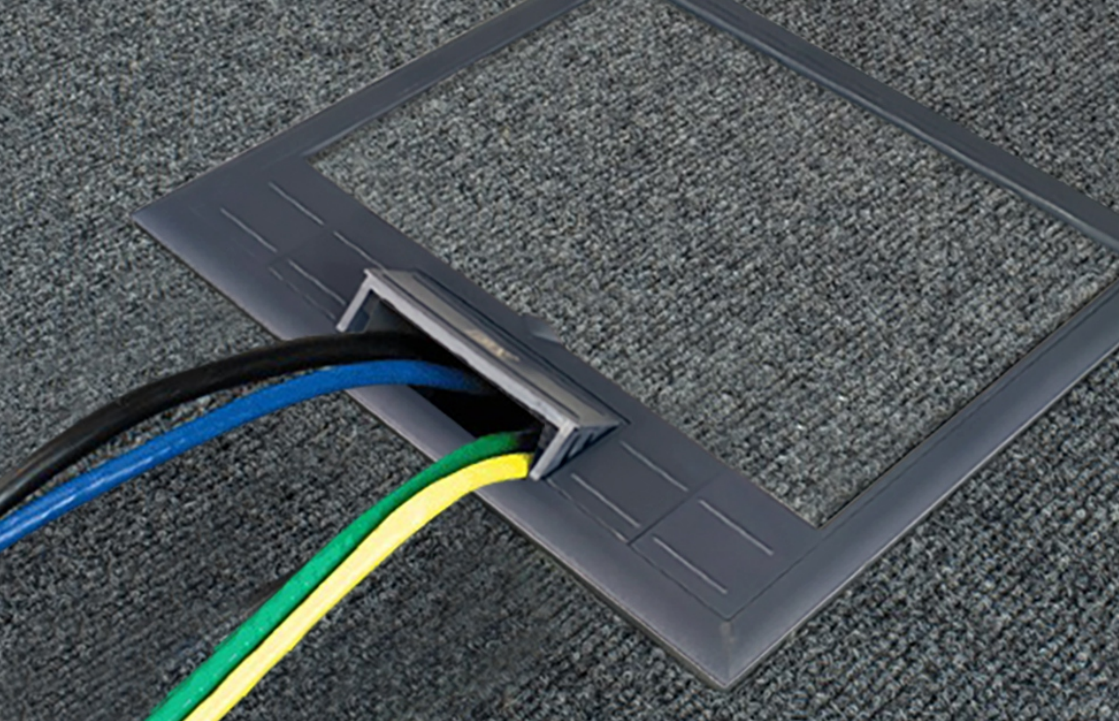

# MX Open Type Floor Boxes

The MX Open Type Floor Box series delivers durability, versatility, and value without compromising on quality, providing a dependable solution for power, data, and multimedia connectivity in a single compact unit. Designed for both concrete and raised access floors, each box features an adjustable base and clamp fixing system for easy installation, while the reversible stainless-steel lid with a flush-mounted 90° top cover ensures long-lasting strength and a neat appearance. A recessed flip-up handle allows effortless access, and the integrated retaining guard protects cables during use. With modular flexibility for Type 45 series sockets, these floor boxes adapt seamlessly to offices, conference rooms, schools, computer labs, and commercial spaces—making them a practical choice for functional and organized environments.

## SPECIFICATION

Module Capacity: **3** (Without Modules)  
 Material: **Stainless Steel**  
 Module Type: 45 Series  
 Opening Mechanism: Flush Mounting System  
 Opening Type: 90 Degrees Top Cover  
 Color: Silver  
 Application: For Concrete Floors



### • MX 7205

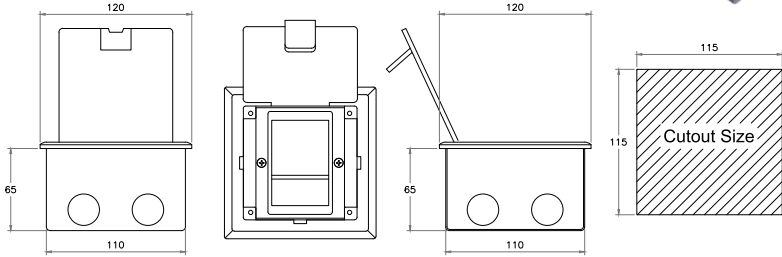

## SPECIFICATION

Module Capacity: **6** (Without Modules)  
 Material: **Stainless Steel**  
 Module Type: 45 Series  
 Opening Mechanism: Flush Mounting System  
 Opening Type: 90 Degrees Top Cover  
 Color: Silver  
 Application: For Concrete Floors



### • MX 7206

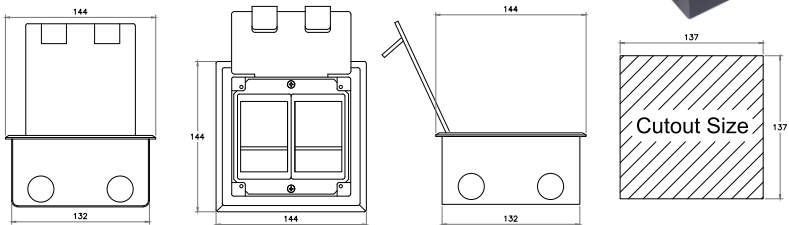

## Customized Multimedia & Sockets on Request :

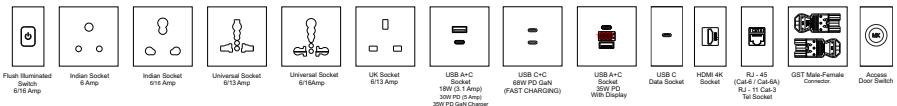

## SPECIFICATION

Module Capacity: **10** (Without Modules)  
 Material: **Stainless Steel**  
 Module Type: 45 Series  
 Opening Mechanism: Flush Mounting System  
 Opening Type: 90 Degrees Top Cover  
 Color: Silver  
 Application: For Concrete Floors

### • MX 7211

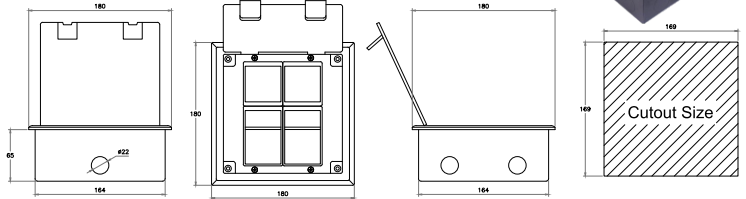

## SPECIFICATION

Module Capacity: **10** Curved (Without Modules)  
 Material: **Stainless Steel**  
 Module Type: 45 Series  
 Opening Mechanism: Flush Mounting System  
 Opening Type: 90 Degrees Top Cover  
 Color: Silver  
 Application: For Concrete Floors

### • MX 7212

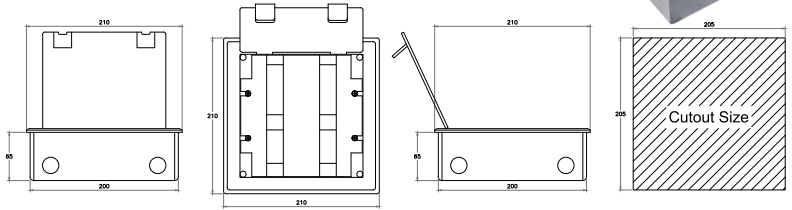

## SPECIFICATION

Module Capacity: **15** (Without Modules)  
 Material: **Stainless Steel**  
 Module Type: 45 Series  
 Opening Mechanism: Flush Mounting System  
 Opening Type: 90 Degrees Top Cover  
 Color: Silver  
 Application: For Concrete Floors

### • MX 7213

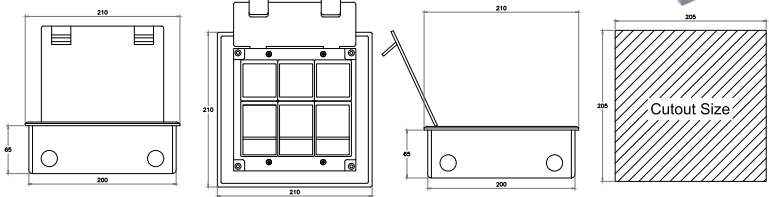

## Customized Multimedia & Sockets on Request :

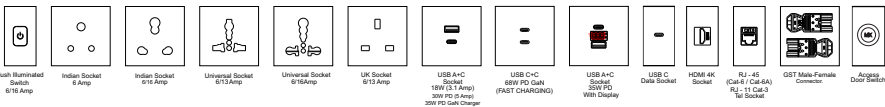

# MX Recess Lid Plastic Floor Boxes

The MX Recess Lid Plastic Floor Box series is a durable yet lightweight solution, designed to accommodate up to twenty-four 45 Series modules within concrete floors, making it ideal for commercial, industrial, and premium residential applications. Constructed from heavy-duty plastic reinforced with stainless steel, it ensures long-lasting strength, while the lid features a galvanized insert plate that adds durability and provides a smooth, flush floor finish. Suitable for recess sizes of 8–11mm, this floor box safeguards electrical and networking connections while maintaining a clean, organized look—delivering a reliable balance of performance, convenience, and design.

## SPECIFICATION

Module Capacity: **8** (Without Modules)  
 Material: **Plastic & Stainless Steel**  
 Module Type: 45 Series  
 Opening Mechanism: Recess Mounting System  
 Opening Type: 8 to 11 mm Lid (8mm Cavity + 3mm thickness galvanized insert plate)  
 Application: For Concrete Floors

### • MX 7207

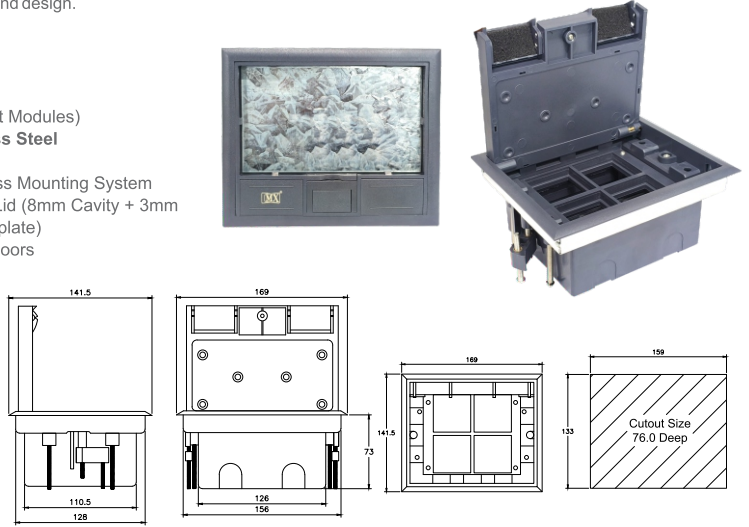

## SPECIFICATION

Module Capacity: **12** (Without Modules)  
 Material: **Plastic & Stainless Steel**  
 Module Type: 45 Series  
 Opening Mechanism: Recess Mounting System  
 Opening Type: 8 to 11 mm Lid (8mm Cavity + 3mm thickness galvanized insert plate)  
 Application: For Concrete Floors

### • MX 7208

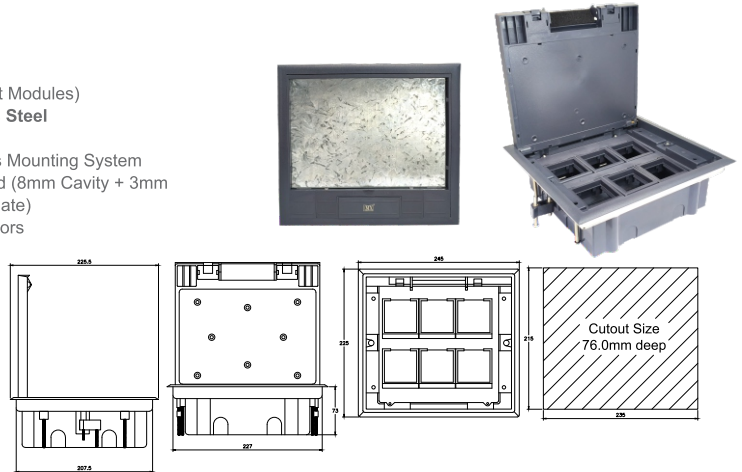

## Customized Multimedia & Sockets on Request : (45x45mm & 22.5x45mm)

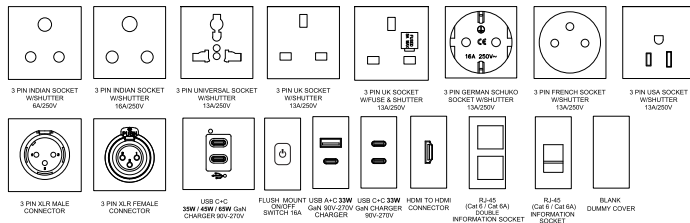

## SPECIFICATION

Module Capacity: **16** (Without Modules)  
 Material: **Plastic & Stainless Steel**  
 Module Type: 45 Series  
 Opening Mechanism: Recess Mounting System  
 Opening Type: 8 to 11 mm Lid (8mm Cavity + 3mm thickness galvanized insert plate)  
 Application: For Concrete Floors



### • MX 7209

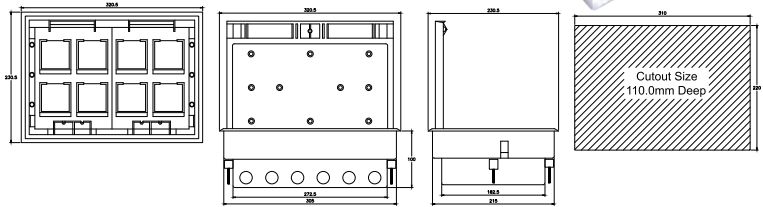

## SPECIFICATION

Module Capacity: **24** (Without Modules)  
 Material: **Plastic & Stainless Steel**  
 Module Type: 45 Series  
 Opening Mechanism: Recess Mounting System  
 Opening Type: 8 to 11 mm Lid (8mm Cavity + 3mm thickness galvanized insert plate)  
 Application: For Concrete Floors



### • MX 7210

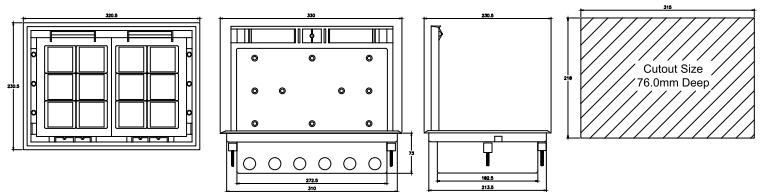

## Customized Multimedia & Sockets on Request : (45x45mm & 22.5x45mm)

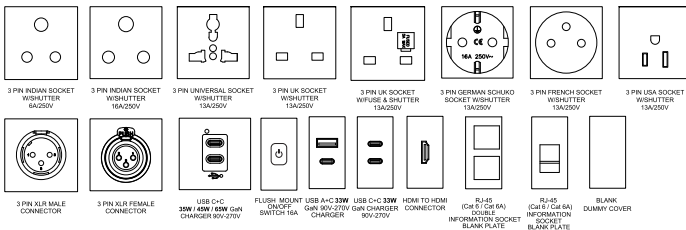



# MX Watertight Floor Boxes With IP65 & IP66 Rating

The MX Watertight Floor Box series is engineered to provide dependable power and data access in concrete or raised floor structures, offering a combination of durability and ease of use for environments where longevity is essential. With stainless steel and zinc alloy lid panels featuring anti-corrosive properties, these units deliver IP65 and IP66 protection against dust ingress and water jets from any direction, ensuring reliable performance even in demanding conditions. A secure lid-locking system protects cables under pressure, while the slide push-button opening mechanism ensures easy access. Available with multiple module options for customization, this series is perfectly suited for outdoor installations that require both protection and versatility.

## SPECIFICATION

- Module Capacity: **3** (Without Modules)
- Material: **Square Stainless Steel Plate**
- IP Rating: **IP66**
- Module Type: 45 Series
- Opening Mechanism: Slide Push Button
- Opening Type: Pull-Type Pop-Up
- Color: Silver
- **MX 7214**

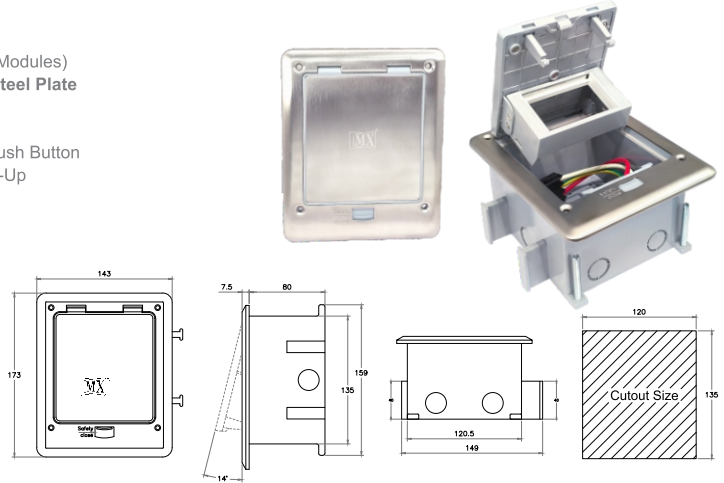

## SPECIFICATION

- Module Capacity: **6** (Without Modules)
- Material: **Square Stainless Steel Plate**
- IP Rating: **IP66**
- Module Type: 45 Series
- Opening Mechanism: Slide Push Button
- Opening Type: Pull-Type Pop-Up
- Color: Silver
- **MX 7215**

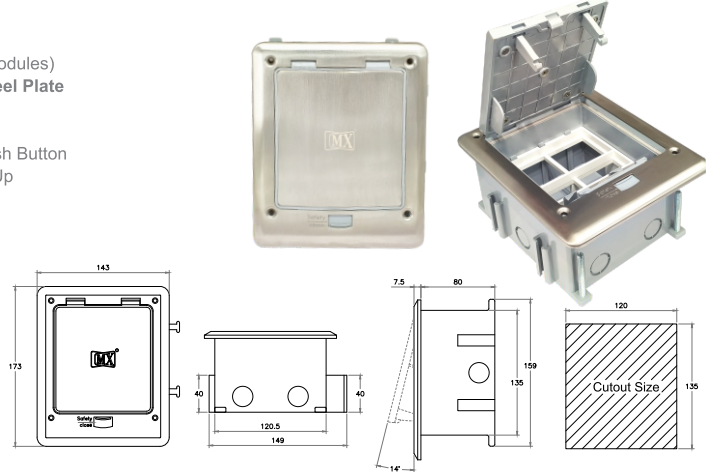

## Customized Multimedia & Sockets on Request : (45x45mm & 22.5x45mm)

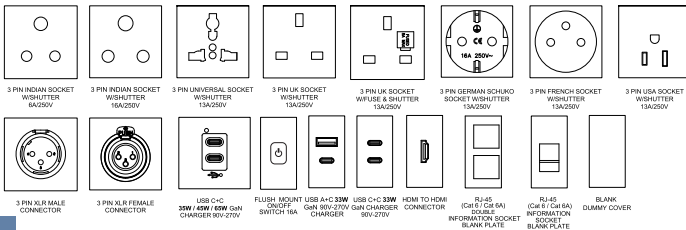

## SPECIFICATION

Module Capacity: 4 + 2 Data Socket (Without Modules)  
 Material: **Round Zinc Alloy Plate**  
 IP Rating: **IP65**  
 Module Type: 45 Series & 2 Data  
 Opening Mechanism: Slide Push Button  
 Opening Type: Leftward Pull-Tab Pop-Up Type  
 Color: Silver  
 • **MX 7216**

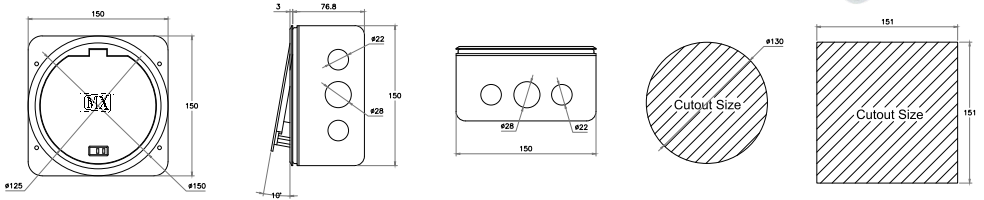

## SPECIFICATION

Module Capacity: 3(Without Modules)  
 Material: **Round Zinc Alloy Plate With Anti Scratch Finishing**  
 IP Rating: **IP65**  
 Module Type: 45 Series  
 Opening Mechanism: Slide Push Button  
 Opening Type: Leftward Pull-Tab Pop-Up Type  
 Color: Silver  
 • **MX 7217**

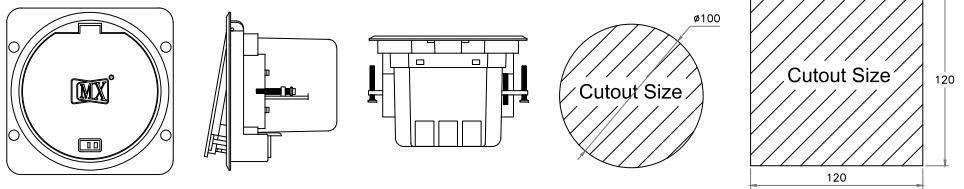

## Customized Multimedia & Sockets on Request : (45x45mm & 22.5x45mm)

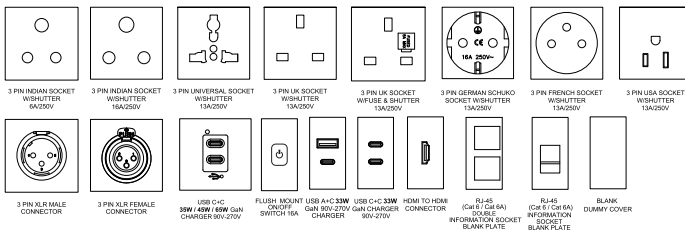

# 45 x 45mm Socket Plates

Compatible With all **European** & **UK** Brands

**MX 7252** 3 Pin UK Socket W/Shutter 2 Module 13A/250V **White**

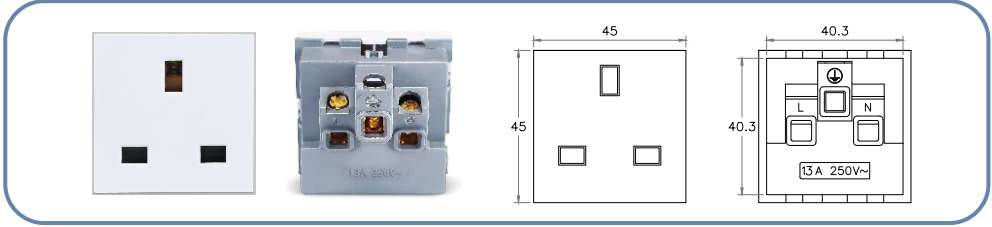

**MX 7253** 3 Pin German Schuko Socket W/Shutter 2 Module 13A/250V **White**

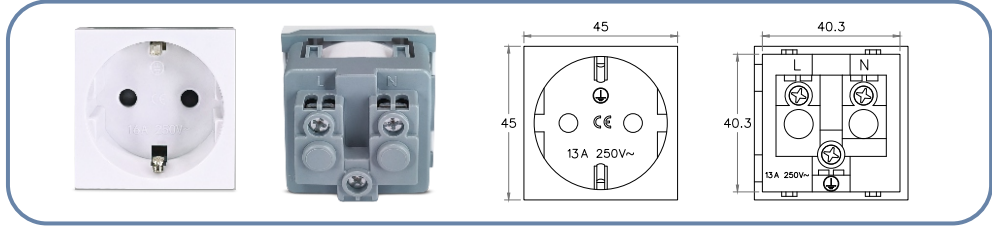

**MX 7254** 3 Pin French Socket W/Shutter 2 Module 13A/250V **White**

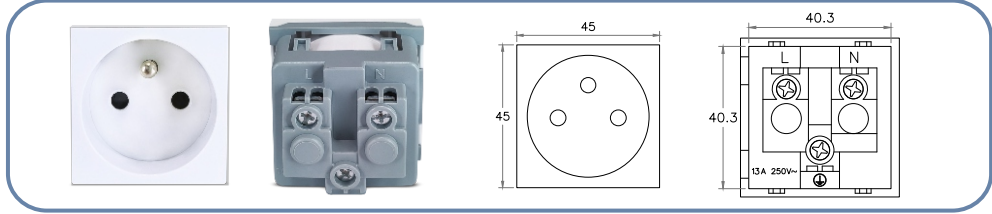

**MX 7255** 3 Pin USA Socket W/Shutter 2 Module 13A/250V **White**

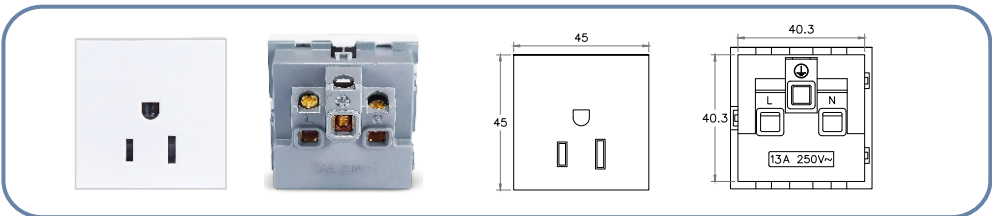

**MX 7256** **White** HDMI To HDMI Connector 1 Module **MX 7257** **Black**

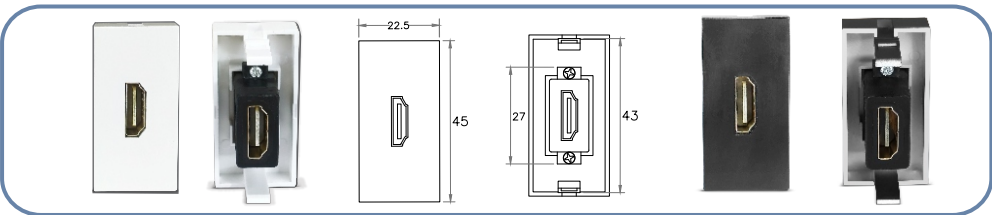

**MX 7258** White RJ-45 (CAT6/CAT6A) Double 1 Module **MX 7259** Black

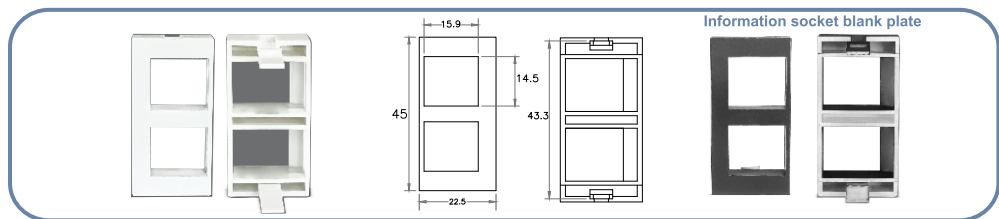

**MX 7260** White RJ-45 (CAT6/CAT6A) 1 Module W/Shutter **MX 7261** Black

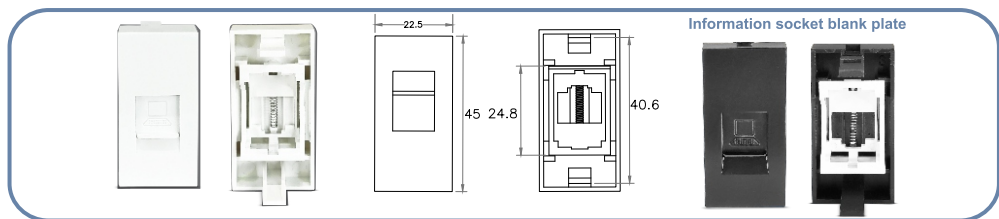

**MX 7262** White Blank Dummy Cover 1 Module **MX 7263** Black

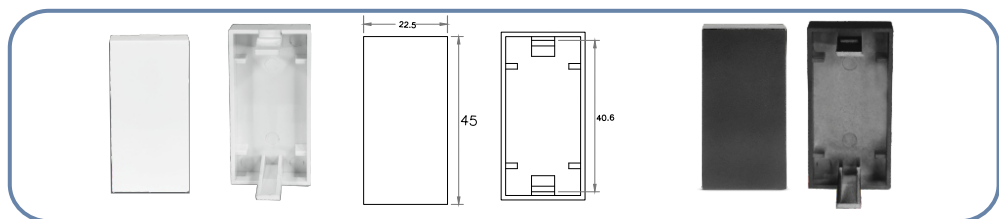

**MX 7264** USB A+C 33W PD GaN Charger (90V-270V)

Color: White - Matt Black - Charcoal Grey

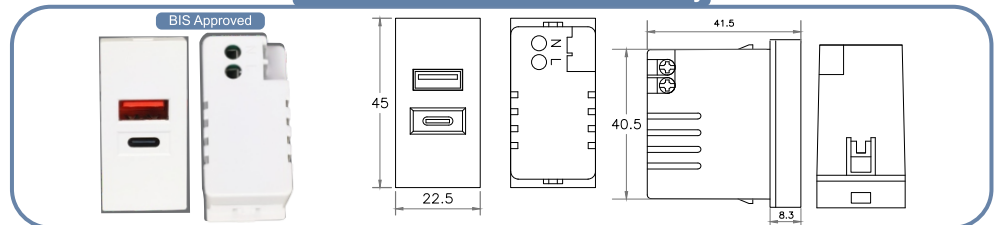

**MX 7265** USB C+C 33W PD GaN Charger (90V-270V)

Color: White - Matt Black - Charcoal Grey

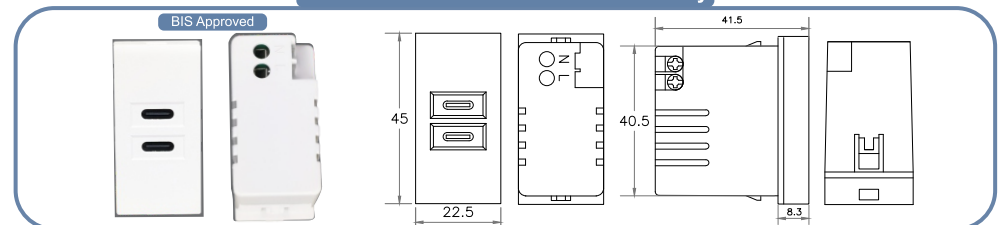

### MX 7266 USB C+C 35W PD GaN Charger (90V-270V)

Color: White - Matt Black - Charcoal Grey

BIS Approved

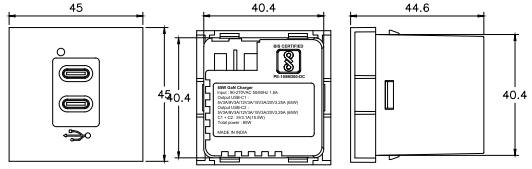

### MX 7267 USB C+C 45W PD GaN Charger (90V-270V)

Color: White - Matt Black - Charcoal Grey

BIS Approved

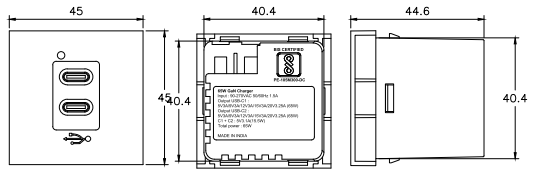

### MX 7268 USB C+C 65W PD GaN Charger (90V-270V)

Color: White - Matt Black - Charcoal Grey

BIS Approved

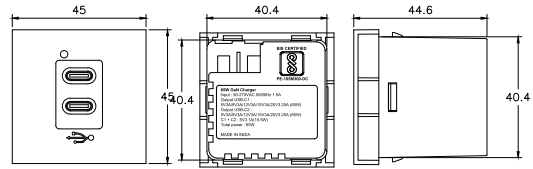

### MX 7269 3 Pin Indian Standard Socket W/Shutter 2 Module 6A/250V

Color: White - Matt Black - Charcoal Grey

ISI Mark Certified

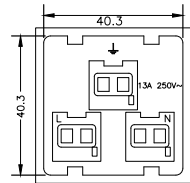
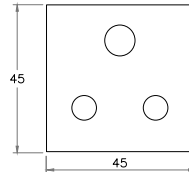
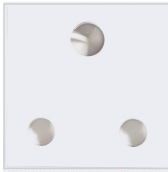

### MX 7270 3 Pin Indian Standard Socket W/Shutter 2 Module 16A/250V

Color: White - Matt Black - Charcoal Grey

ISI Mark Certified

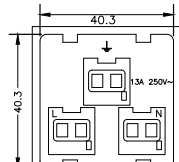
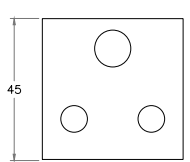
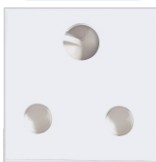

**MX 7271** 3 Pin UK Socket W/Shutter 2 Module 13A/250V W/ FUSE

Color: White - Matt Black - Charcoal Grey

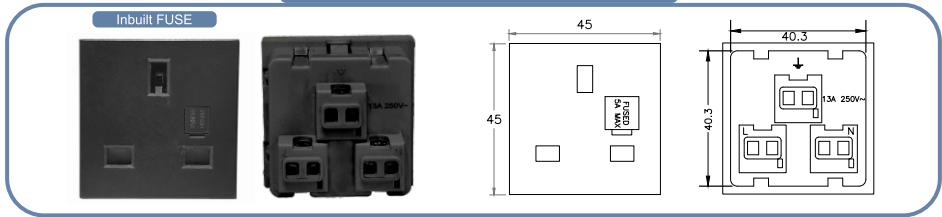

**MX 7272** White 3 Pin XLR Male Connector **MX 7273** White 3 Pin XLR Female Connector



**MX 7274** White Flush Mount illuminated ON/OFF switch 6Amps Black

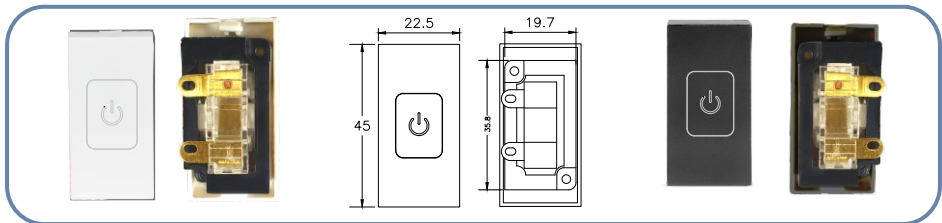

**MX 7275** White Flush Mount illuminated ON/OFF switch 16Amps Black

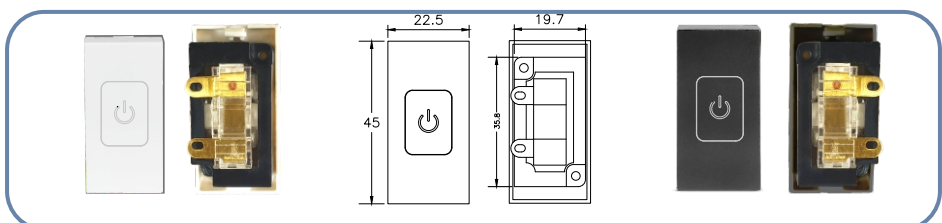

**MX 7276** White Blank Dummy Cover 11.5x45mm Modular Socket Plate **MX 7277** Black

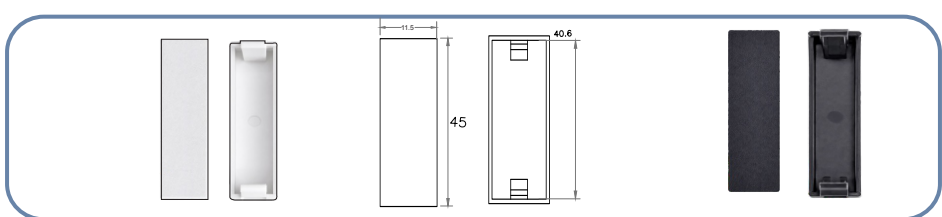

**MX 7278** **White** Blank Dummy Cover 45x45mm Modular Socket Plate

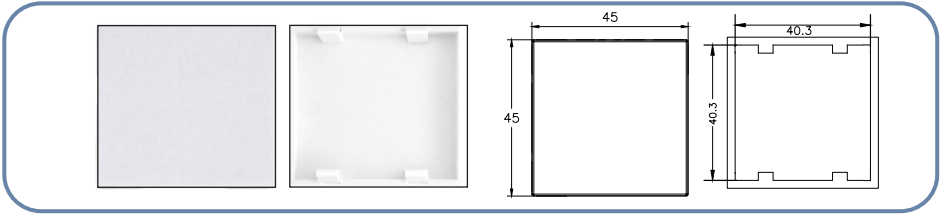

**MX 7279** **Black** Blank Dummy Cover 45x45mm Modular Socket Plate

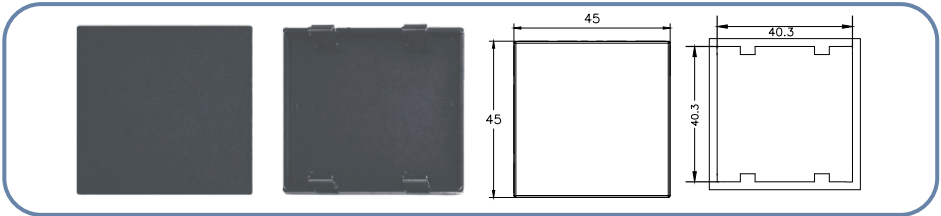

**MX 7280** Manual Pass Through (2 Way) **Black**

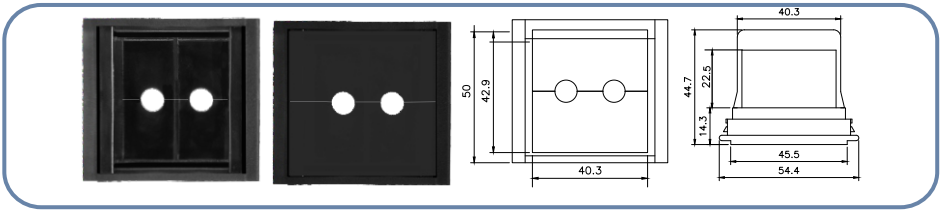

**MX 7281** **White** USB A 2.0 KEY STONE FACE PLATE (JOINER) 1 Module **MX 7282** **Black**  
22.5x45mm Modular Socket Plate

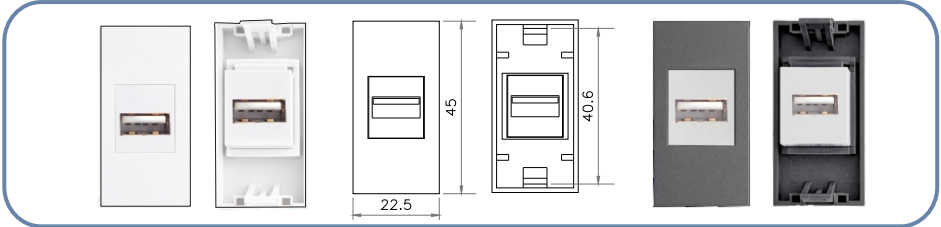

**MX 7283** **White** USB A 3.0 KEY STONE FACE PLATE (JOINER) 1 Module **MX 7284** **Black**  
22.5x45mm Modular Socket Plate

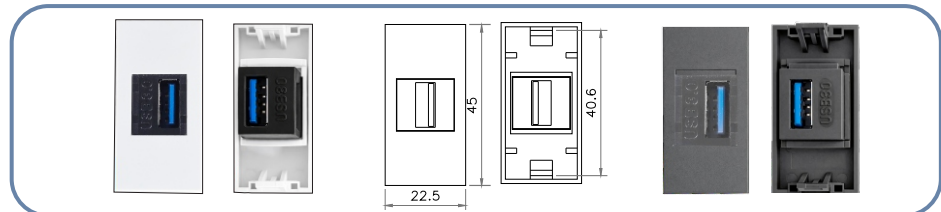

**MX 7285** White USB TYPE C KEY STONE FACE PLATE (JOINER) 1 Module **MX 7286** Black  
2.5x45mm Modular Socket Plate

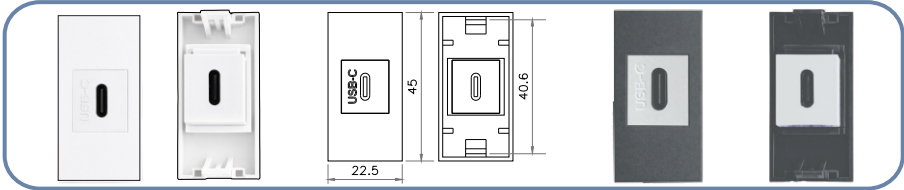

**MX 7287** White CAT 6 DATA KEY STONE FACE PLATE (JOINER) (INLINE COUPLER) 1 Module **MX 7288** Black  
22.5x45mm Modular Socket Plate

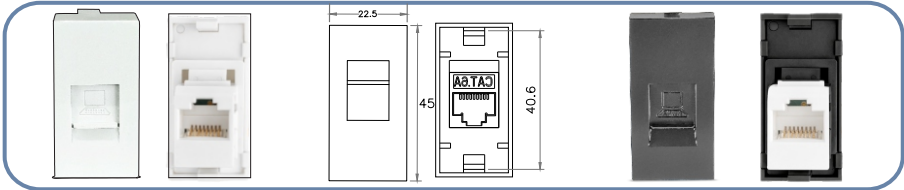

**MX 7289** White CAT 6A DATA KEY STONE FACE PLATE (JOINER) (INLINE COUPLER) 1 Module **MX 7290** Black  
22.5x45mm Modular Socket Plate

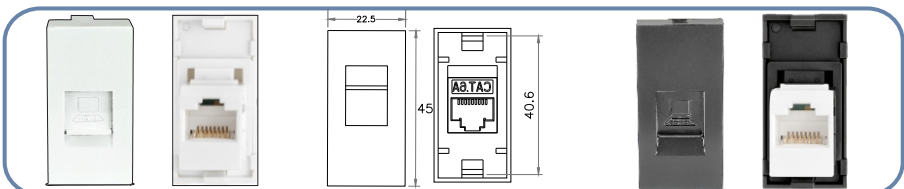

**MX 7291** White CAT 6A DATA KEY STONE FACE PLATE (JOINER) (SHIELDED INLINE COUPLER) 1 Module **MX 7292** Black  
22.5x45mm Modular Socket Plate

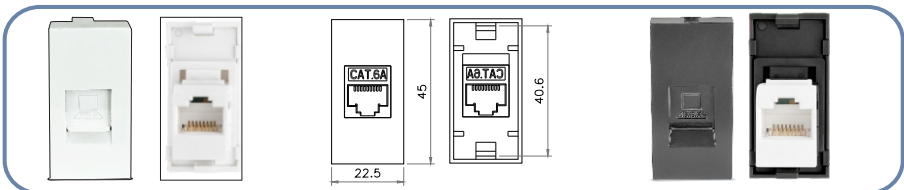

**MX 7293** White 3 WAY MANUAL PASS THROUGH CABLE RETRACTOR 1 Module **MX 7294** Black  
22.5x45mm Modular Socket Plate

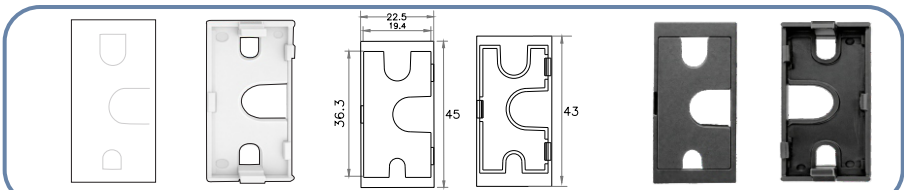





**MX 7295**





**1 WAY FEMALE HDMI 4K  
FACE PLATE MODULAR SOCKET 22.5X45MM**  
Cable Dia: 7mm Cable  
Length: 0.25mm (25cm)



Product Image	Model No.	SPECIFICATION
	<b>MX 7370</b> (10 mtrs)	No. of Outlets : 1 Poles : 3 Pin Rated Current : <b>16A</b> Cable Type : H03VV-F <b>ISI Marked Certified</b> Cable Section : <b>1.5mm<sup>2</sup></b> Material : PP
	<b>MX 7370A</b> (15 mtrs)	
	<b>MX 7370B</b> (20 mtrs)	
	<b>MX 7371</b> ( 10 mtrs )	No. of Outlets : 1 Poles : 3 Pin Rated Current : <b>32A</b> Cable Type : H03VV-F <b>ISI Marked Certified</b> Cable Section : <b>2.5mm<sup>2</sup></b> Material : PP
	<b>MX 7371A</b> (15 mtrs)	
	<b>MX 7371B</b> (20 mtrs)	
	<b>MX 7372</b> (10 mtrs)	No. of Outlets : 1 Poles : 3 Pin Rated Current : <b>16A</b> Cable Type : H03VV-F <b>ISI Marked Certified</b> Cable Section : <b>1.5mm<sup>2</sup></b> Material : ABS+STEEL
	<b>MX 7372A</b> (15 mtrs)	
	<b>MX 7372B</b> (20 mtrs)	
	<b>MX 7373</b> (10 mtrs)	No. of Outlets : 1 Poles : 3 Pin Rated Current : <b>32A</b> Cable Type : H03VV-F <b>ISI Marked Certified</b> Cable Section : <b>2.5mm<sup>2</sup></b> Material : ABS+STEEL
	<b>MX 7373A</b> (15 mtrs)	
	<b>MX 7373B</b> (20 mtrs)	

Product Image	Model No.	SPECIFICATION
	<b>MX 7374</b> (20 mtrs)	No. of Outlets : 2 Poles : 3 Pin IP Rating : IP44 Rated Current : <b>16A</b> Rated Voltage : 220-250V Cable Section : <b>1.5mm<sup>2</sup></b> Power Switch : N/A
	<b>MX 7374A</b> (30 mtrs)	
	<b>MX 7374B</b> (50 mtrs)	
	<b>MX 7374C</b> ( 20 mtrs )	No. of Outlets : 2 Poles : 3 Pin IP Rating : IP44 Rated Current : <b>32A</b> Rated Voltage : 220-250V Cable Section : <b>2.5mm<sup>2</sup></b>
	<b>MX 7374D</b> ( 30 mtrs )	
	<b>MX 7374E</b> ( 50 mtrs )	
	<b>MX 7375</b> (20 mtrs)	No. of Outlets : 2 Poles : 3 Pin IP Rating : IP44 Rated Current : 16A Rated Voltage : 220-250V Cable Section : 1.5mm <sup>2</sup> Power Switch : 32 AMP ELCB Switch
	<b>MX 7375A</b> (30 mtrs)	
	<b>MX 7375B</b> (50 mtrs)	
	<b>MX 7376</b> (20 mtrs)	No. of Outlets : 2 Poles : 3 Pin IP Rating : IP44 Rated Current : 16A Rated Voltage : 220-250V Cable Section : 1.5mm <sup>2</sup> Power Switch : 32 AMP ELCB Switch
	<b>MX 7376A</b> (30 mtrs)	
	<b>MX 7376B</b> (50 mtrs)	



Product Image	Model No.	SPECIFICATION
	<p><b>MX 7377</b> ( 20 mtrs )</p>	<p>No. of Outlets : 2                      Poles : 3 Pin                      IP Rating : IP44                      Rated Current : <b>16A</b>                      Rated Voltage : 220-250V                      Cable Section : <b>1.5mm<sup>2</sup></b>                      Power Switch : N/A</p>
	<p><b>MX 7377A</b> ( 30 mtrs )</p>	
	<p><b>MX 7377B</b> (20 mtrs)</p>	<p>No. of Outlets : 2                      Poles : 3 Pin                      IP Rating : IP44                      Rated Current : 32A                      Rated Voltage : 220-250V                      Cable Section : 2.5mm<sup>2</sup>                      Power Switch : N/A</p>
	<p><b>MX 7377C</b> (30 mtrs)</p>	
	<p><b>MX 7378</b> ( 20 mtrs )</p>	<p>No. of Outlets : 2                      Poles : 3 Pin                      IP Rating : IP44                      Rated Current : <b>32A</b>                      Rated Voltage : 220-250V                      Cable Section : <b>2.5mm<sup>2</sup></b>                      Power Switch : 32 AMP                      ELCB Switch</p>
	<p><b>MX 7378A</b> ( 30 mtrs )</p>	

# MX Cords & Power Extensions



**Product Image**

**Model No.**

**SPECIFICATION**



**MX 7368**  
( 15 mtrs )

**MX 7368A**  
( 20 mtrs )

**MX 7368B**  
( 25 mtrs )

**MX 7368C**  
( 30 mtrs )

**Poles : 3 Pin**

**IP Rating : IP44**

**Rated Current : 16A**

**Rated Voltage : 380-415V**

**Hour Position : 6h**

**Cable Section : 2.5mm<sup>2</sup>**



**MX 7369**  
( 15 mtrs )

**MX 7369A**  
( 20 mtrs )

**MX 7369B**  
( 20 mtrs )

**MX 7369C**  
( 25 mtrs )

**Poles : 5 Pin**

**IP Rating : IP67**

**Rated Current : 16A**

**Rated Voltage : 380-415V**

**Hour Position : 6h**

**Cable Section : 2.5mm<sup>2</sup>**



# High End Type Industrial Plugs & Sockets

HSN-8536

Description	Product Image	Model No.	IP Protection	Amp	Number of Pole	Voltage	Earthing
WALL MOUNTED SOCKET		<b>MX 7301</b>	IP44	16	2+E	230V	6h
		<b>MX 7379</b>	IP44	16	3+E	400V	6h
		<b>MX 7303</b>	IP44	16	3+E+N	400V	6h
		<b>MX 7302</b>	IP44	32	2+E	230V	6h
		<b>MX 7380</b>	IP44	32	3+E	400V	6h
		<b>MX 7304</b>	IP44	32	3+E+N	400V	6h
		<b>MX 7381</b>	IP44	63	2+E	230V	6h
		<b>MX 7382</b>	IP44	63	3+E	400V	6h
		<b>MX 7305</b>	IP44	63	3+E+N	400V	6h
WALL MOUNTED SOCKET		<b>MX 7306</b>	IP67	16	2+E	230V	6h
		<b>MX 7383</b>	IP67	16	3+E	400V	6h
		<b>MX 7307</b>	IP67	16	3+E+N	400V	6h
		<b>MX 7384</b>	IP67	32	2+E	230V	6h
		<b>MX 7385</b>	IP67	32	3+E	400V	6h
		<b>MX 7308</b>	IP67	32	3+E+N	400V	6h
		<b>MX 7386</b>	IP67	63	2+E	230V	6h
		<b>MX 7387</b>	IP67	63	3+E	400V	6h
		<b>MX 7309</b>	IP67	63	3+E+N	400V	6h
		<b>MX 7388</b>	IP67	125	2+E	230V	6h
		<b>MX 7389</b>	IP67	125	3+E	400V	6h
		<b>MX 7390</b>	IP67	125	3+E+N	400V	6h
PANEL MOUNTED SOCKET ANGLED		<b>MX 7310</b>	IP44	16	2+E	230V	6h
		<b>MX 7391</b>	IP44	16	3+E	400V	6h
		<b>MX 7313</b>	IP44	16	3+E+N	400V	6h
		<b>MX 7311</b>	IP44	32	2+E	230V	6h
		<b>MX 7395</b>	IP44	32	3+E	400V	6h
		<b>MX 7314</b>	IP44	32	3+E+N	400V	6h
		<b>MX 7312</b>	IP44	63	2+E	230V	6h
		<b>MX 7393</b>	IP44	63	3+E	400V	6h
<b>MX 7315</b>	IP44	63	3+E+N	400V	6h		

**Product Image**

**Description**

Model No.	IP Protection	Amp	Number of Pole	Voltage	Earthing
<b>MX 7316</b>	<b>IP67</b>	<b>16</b>	<b>2+E</b>	<b>230V</b>	<b>6h</b>
<b>MX 7394</b>	<b>IP67</b>	<b>16</b>	<b>3+E</b>	<b>400V</b>	<b>6h</b>
<b>MX 7318</b>	<b>IP67</b>	<b>16</b>	<b>3+E+N</b>	<b>400V</b>	<b>6h</b>
<b>MX 7317</b>	<b>IP67</b>	<b>32</b>	<b>2+E</b>	<b>230V</b>	<b>6h</b>
<b>MX 7392</b>	<b>IP67</b>	<b>32</b>	<b>3+E</b>	<b>400V</b>	<b>6h</b>
<b>MX 7319</b>	<b>IP67</b>	<b>32</b>	<b>3+E+N</b>	<b>400V</b>	<b>6h</b>
<b>MX 7396</b>	<b>IP67</b>	<b>63</b>	<b>2+E</b>	<b>230V</b>	<b>6h</b>
<b>MX 7397</b>	<b>IP67</b>	<b>63</b>	<b>3+E</b>	<b>400V</b>	<b>6h</b>
<b>MX 7320</b>	<b>IP67</b>	<b>63</b>	<b>3+E+N</b>	<b>400V</b>	<b>6h</b>
<b>MX 7398</b>	<b>IP67</b>	<b>125</b>	<b>2+E</b>	<b>230V</b>	<b>6h</b>
<b>MX 7399</b>	<b>IP67</b>	<b>125</b>	<b>3+E</b>	<b>400V</b>	<b>6h</b>
<b>MX 7321</b>	<b>IP67</b>	<b>125</b>	<b>3+E+N</b>	<b>400V</b>	<b>6h</b>
<b>MX 7322</b>	<b>IP44</b>	<b>16</b>	<b>2+E</b>	<b>230V</b>	<b>6h</b>
<b>MX 7400</b>	<b>IP44</b>	<b>16</b>	<b>3+E</b>	<b>400V</b>	<b>6h</b>
<b>MX 7324</b>	<b>IP44</b>	<b>16</b>	<b>3+E+N</b>	<b>400V</b>	<b>6h</b>
<b>MX 7323</b>	<b>IP44</b>	<b>32</b>	<b>2+E</b>	<b>230V</b>	<b>6h</b>
<b>MX 7401</b>	<b>IP44</b>	<b>32</b>	<b>3+E</b>	<b>400V</b>	<b>6h</b>
<b>MX 7325</b>	<b>IP44</b>	<b>32</b>	<b>3+E+N</b>	<b>400V</b>	<b>6h</b>
<b>MX 7402</b>	<b>IP44</b>	<b>63</b>	<b>2+E</b>	<b>230V</b>	<b>6h</b>
<b>MX 7403</b>	<b>IP44</b>	<b>63</b>	<b>3+E</b>	<b>400V</b>	<b>6h</b>
<b>MX 7326</b>	<b>IP44</b>	<b>63</b>	<b>3+E+N</b>	<b>400V</b>	<b>6h</b>
<b>MX 7327</b>	<b>IP67</b>	<b>16</b>	<b>2+E</b>	<b>230V</b>	<b>6h</b>
<b>MX 7404</b>	<b>IP67</b>	<b>16</b>	<b>3+E</b>	<b>400V</b>	<b>6h</b>
<b>MX 7405</b>	<b>IP67</b>	<b>16</b>	<b>3+E+N</b>	<b>400V</b>	<b>6h</b>
<b>MX 7406</b>	<b>IP67</b>	<b>32</b>	<b>2+E</b>	<b>230V</b>	<b>6h</b>
<b>MX 7407</b>	<b>IP67</b>	<b>32</b>	<b>3+E</b>	<b>400V</b>	<b>6h</b>
<b>MX 7408</b>	<b>IP67</b>	<b>32</b>	<b>3+E+N</b>	<b>400V</b>	<b>6h</b>
<b>MX 7409</b>	<b>IP67</b>	<b>63</b>	<b>2+E</b>	<b>230V</b>	<b>6h</b>
<b>MX 7410</b>	<b>IP67</b>	<b>63</b>	<b>3+E</b>	<b>400V</b>	<b>6h</b>
<b>MX 7411</b>	<b>IP67</b>	<b>63</b>	<b>3+E+N</b>	<b>400V</b>	<b>6h</b>
<b>MX 7510</b>	<b>IP67</b>	<b>125</b>	<b>3+E</b>	<b>400V</b>	<b>6h</b>

**PANEL MOUNTED SOCKET ANGLED**





**PANEL MOUNTED SOCKET STRAIGHT**



**PANEL MOUNTED SOCKET STRAIGHT**



Description	Product Image	Model No.	IP Protection	Amp	Number of Pole	Voltage	Earthing
WALL MOUNTED PLUG		MX 7412	IP44	16	2+E	230V	6h
		MX 7413	IP44	16	3+E	400V	6h
		MX 7414	IP44	16	3+E+N	400V	6h
		MX 7415	IP44	32	2+E	230V	6h
		MX 7416	IP44	32	3+E	400V	6h
		MX 7417	IP44	32	3+E+N	400V	6h
		MX 7418	IP44	63	2+E	230V	6h
		MX 7419	IP44	63	3+E	400V	6h
		MX 7420	IP44	63	3+E+N	400V	6h
		WALL MOUNTED PLUG		MX 7421	IP67	16	2+E
MX 7422	IP67			16	3+E	400V	6h
MX 7423	IP67			16	3+E+N	400V	6h
MX 7424	IP67			32	2+E	230V	6h
MX 7425	IP67			32	3+E	400V	6h
MX 7426	IP67			32	3+E+N	400V	6h
MX 7427	IP67			63	2+E	230V	6h
MX 7428	IP67			63	3+E	400V	6h
MX 7429	IP67			63	3+E+N	400V	6h
PANEL MOUNTED PLUG				MX 7433	IP67	125	2+E
		MX 7434	IP67	125	3+E	400V	6h
		MX 7435	IP67	125	3+E+N	400V	6h
		MX 7436	IP44	16	2+E	230V	6h
		MX 7437	IP44	16	3+E	400V	6h
		MX 7438	IP44	16	3+E+N	400V	6h
		MX 7439	IP44	32	2+E	230V	6h
		MX 7440	IP44	32	3+E	400V	6h
		MX 7441	IP44	32	3+E+N	400V	6h



## Product Image

## Description

Model No.	IP Protection	Amp	Number of Pole	Voltage	Earthing
-----------	---------------	-----	----------------	---------	----------

### PANEL MOUNTED PLUG



<a href="#">MX 7442</a>	<a href="#">IP67</a>	16	<a href="#">2+E</a>	<a href="#">230V</a>	<a href="#">6h</a>
<a href="#">MX 7443</a>	<a href="#">IP67</a>	16	<a href="#">3+E</a>	<a href="#">400V</a>	<a href="#">6h</a>
<a href="#">MX 7444</a>	<a href="#">IP67</a>	16	<a href="#">3+E+N</a>	<a href="#">400V</a>	<a href="#">6h</a>
<a href="#">MX 7445</a>	<a href="#">IP67</a>	32	<a href="#">2+E</a>	<a href="#">230V</a>	<a href="#">6h</a>
<a href="#">MX 7446</a>	<a href="#">IP67</a>	32	<a href="#">3+E</a>	<a href="#">400V</a>	<a href="#">6h</a>
<a href="#">MX 7447</a>	<a href="#">IP67</a>	32	<a href="#">3+E+N</a>	<a href="#">400V</a>	<a href="#">6h</a>
<a href="#">MX 7448</a>	<a href="#">IP67</a>	63	<a href="#">2+E</a>	<a href="#">230V</a>	<a href="#">6h</a>
<a href="#">MX 7449</a>	<a href="#">IP67</a>	63	<a href="#">3+E</a>	<a href="#">400V</a>	<a href="#">6h</a>
<a href="#">MX 7450</a>	<a href="#">IP67</a>	63	<a href="#">3+E+N</a>	<a href="#">400V</a>	<a href="#">6h</a>
<a href="#">MX 7451</a>	<a href="#">IP67</a>	125	<a href="#">2+E</a>	<a href="#">230V</a>	<a href="#">6h</a>
<a href="#">MX 7452</a>	<a href="#">IP67</a>	125	<a href="#">3+E</a>	<a href="#">400V</a>	<a href="#">6h</a>
<a href="#">MX 7453</a>	<a href="#">IP67</a>	125	<a href="#">3+E+N</a>	<a href="#">400V</a>	<a href="#">6h</a>

### PLUG



<a href="#">MX 7328</a>	<a href="#">IP44</a>	16	<a href="#">2+E</a>	<a href="#">230V</a>	<a href="#">6h</a>
<a href="#">MX 7454</a>	<a href="#">IP44</a>	16	<a href="#">3+E</a>	<a href="#">400V</a>	<a href="#">6h</a>
<a href="#">MX 7331</a>	<a href="#">IP44</a>	16	<a href="#">3+E+N</a>	<a href="#">400V</a>	<a href="#">6h</a>
<a href="#">MX 7329</a>	<a href="#">IP44</a>	32	<a href="#">2+E</a>	<a href="#">230V</a>	<a href="#">6h</a>
<a href="#">MX 7455</a>	<a href="#">IP44</a>	32	<a href="#">3+E</a>	<a href="#">400V</a>	<a href="#">6h</a>
<a href="#">MX 7332</a>	<a href="#">IP44</a>	32	<a href="#">3+E+N</a>	<a href="#">400V</a>	<a href="#">6h</a>
<a href="#">MX 7330</a>	<a href="#">IP44</a>	63	<a href="#">2+E</a>	<a href="#">230V</a>	<a href="#">6h</a>
<a href="#">MX 7456</a>	<a href="#">IP44</a>	63	<a href="#">3+E</a>	<a href="#">400V</a>	<a href="#">6h</a>
<a href="#">MX 7333</a>	<a href="#">IP44</a>	63	<a href="#">3+E+N</a>	<a href="#">400V</a>	<a href="#">6h</a>

### PLUG





<a href="#">MX 7334</a>	<a href="#">IP67</a>	16	<a href="#">2+E</a>	<a href="#">230V</a>	<a href="#">6h</a>
<a href="#">MX 7457</a>	<a href="#">IP67</a>	16	<a href="#">3+E</a>	<a href="#">400V</a>	<a href="#">6h</a>
<a href="#">MX 7336</a>	<a href="#">IP67</a>	16	<a href="#">3+E+N</a>	<a href="#">400V</a>	<a href="#">6h</a>
<a href="#">MX 7335</a>	<a href="#">IP67</a>	32	<a href="#">2+E</a>	<a href="#">230V</a>	<a href="#">6h</a>
<a href="#">MX 7458</a>	<a href="#">IP67</a>	32	<a href="#">3+E</a>	<a href="#">400V</a>	<a href="#">6h</a>
<a href="#">MX 7337</a>	<a href="#">IP67</a>	32	<a href="#">3+E+N</a>	<a href="#">400V</a>	<a href="#">6h</a>
<a href="#">MX 7459</a>	<a href="#">IP67</a>	63	<a href="#">2+E</a>	<a href="#">230V</a>	<a href="#">6h</a>
<a href="#">MX 7460</a>	<a href="#">IP67</a>	63	<a href="#">3+E</a>	<a href="#">400V</a>	<a href="#">6h</a>
<a href="#">MX 7338</a>	<a href="#">IP67</a>	63	<a href="#">3+E+N</a>	<a href="#">400V</a>	<a href="#">6h</a>
<a href="#">MX 7461</a>	<a href="#">IP67</a>	125	<a href="#">3+E</a>	<a href="#">230V</a>	<a href="#">6h</a>
<a href="#">MX 7462</a>	<a href="#">IP67</a>	125	<a href="#">3+E</a>	<a href="#">400V</a>	<a href="#">6h</a>
<a href="#">MX 7339</a>	<a href="#">IP67</a>	125	<a href="#">3+E</a>	<a href="#">400V</a>	<a href="#">6h</a>



# High End Type Industrial Plugs & Sockets

HSN-8536

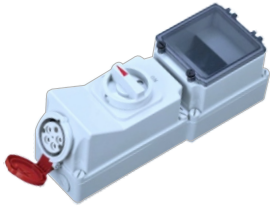
Description	Product Image	Model No.	IP Protection	Amp	Number of Pole	Voltage	Earthing
CONNECTOR		MX 7340	IP44	16	2+E	230V	6h
		MX 7463	IP44	16	3+E	400V	6h
		MX 7342	IP44	16	3+E+N	400V	6h
		MX 7341	IP44	32	2+E	230V	6h
		MX 7464	IP44	32	3+E	400V	6h
		MX 7343	IP44	32	3+E+N	400V	6h
		MX 7465	IP44	63	2+E	230V	6h
		MX 7466	IP44	63	3+E	400V	6h
		MX 7344	IP44	63	3+E+N	400V	6h
CONNECTOR		MX 7467	IP67	16	2+E	230V	6h
		MX 7468	IP67	16	3+E	400V	6h
		MX 7345	IP67	16	3+E+N	400V	6h
		MX 7469	IP67	32	2+E	230V	6h
		MX 7470	IP67	32	3+E	400V	6h
		MX 7346	IP67	32	3+E+N	400V	6h
		MX 7471	IP67	63	2+E	230V	6h
		MX 7472	IP67	63	3+E	400V	6h
		MX 7347	IP67	63	3+E+N	400V	6h
		MX 7473	IP67	125	2+E	230V	6h
		MX 7474	IP67	125	3+E	400V	6h
		MX 7348	IP67	125	3+E+N	400V	6h
INTERLOCK SOCKET WITH DUO		MX 7475	IP44	16	2+E	230V	6h
		MX 7476	IP44	16	3+E	400V	6h
		MX 7477	IP44	16	3+E+N	400V	6h
		MX 7478	IP44	32	2+E	230V	6h
		MX 7479	IP44	32	3+E	400V	6h
		MX 7480	IP44	32	3+E+N	400V	6h
		MX 7481	IP44	63	2+E	230V	6h
		MX 7482	IP44	63	3+E	400V	6h
MX 7483	IP44	63	3+E+N	400V	6h		



## Product Image

## Description

### INTERLOCK SOCKET WITH DUO

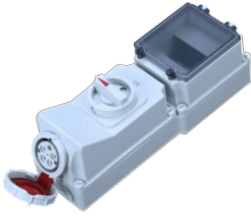

### INTERLOCK SWITCHED SOCKET



### INTERLOCK SWITCHED SOCKET



Model No.	IP Protection	Amp	Number of Pole	Voltage	Earthing
MX 7349	IP67	16	2+E	230V	6h
MX 7484	IP67	16	3+E	400V	6h
MX 7351	IP67	16	3+E+N	400V	6h
MX 7350	IP67	32	2+E	230V	6h
MX 7485	IP67	32	3+E	400V	6h
MX 7352	IP67	32	3+E+N	400V	6h
MX 7486	IP67	63	2+E	230V	6h
MX 7487	IP67	63	3+E	400V	6h
MX 7353	IP67	63	3+E+N	400V	6h
MX 7488	IP67	125	2+E	230V	6h
MX 7489	IP67	125	3+E	400V	6h
MX 7490	IP67	125	3+E+N	400V	6h
MX 7491	IP44	16	2+E	230V	6h
MX 7492	IP44	16	3+E	400V	6h
MX 7493	IP44	16	3+E+N	400V	6h
MX 7494	IP44	32	2+E	230V	6h
MX 7495	IP44	32	3+E	400V	6h
MX 7496	IP44	32	3+E+N	400V	6h
MX 7497	IP44	63	2+E	230V	6h
MX 7498	IP44	63	3+E	400V	6h
MX 7499	IP44	63	3+E+N	400V	6h
MX 7354	IP67	16	2+E	230V	6h
MX 7500	IP67	16	3+E	400V	6h
MX 7356	IP67	16	3+E+N	400V	6h
MX 7355	IP67	32	2+E	230V	6h
MX 7501	IP67	32	3+E	400V	6h
MX 7357	IP67	32	3+E+N	400V	6h
MX 7502	IP67	63	2+E	230V	6h
MX 7503	IP67	63	3+E	400V	6h
MX 7358	IP67	63	3+E+N	400V	6h
MX 7504	IP67	125	3+E	230V	6h
MX 7505	IP67	125	3+E	400V	6h
MX 7506	IP67	125	3+E+N	400V	6h



# High End Type Industrial Plugs & Sockets







HSN-8536

Description	Product Image	Model No.	IP Protection	Amp	Number of Pole	Voltage	Earthing
INTERLOCK SOCKET		MX 7507	IP67	16	2+E	230V	
SCHUKO PLUG		MX 7359	IP44	16/20	2 PIN	230V	
SCHUKO SOCKET Screw Terminals		MX 7360 BL	IP54	16	2 PIN	230V	
		MX 7360 BK	IP54	16	2 PIN	230V	
SCHUKO CONNECTOR		MX 7361	IP54	16	2 PIN	230V	
SCHUKO SOCKET SCREW TERMINALS		MX 7362 WH	IP67	16	2 PIN	230V	
		MX 7362 BL	IP67	16	2 PIN	230V	
SCHUKO CONNECTOR		MX 7508	IP67	16	2 PIN	230V	
SCHUKO PLUG		MX 7509	IP67	16	2 PIN	230V	
UNIVERSAL SOCKET Screw Terminals		MX 7363	IP54	16	2 PIN	230V	



## Product Image

## Description

	Product Image	Model No.	IP Protection	Amp	Number of Pole	Voltage	Earthing
MULTI-FUNCTIONAL JUNCTION BOX		MX 7364	IP44	16	2+E	230V	6h
		MX 7365	IP44	16	3+E	400V	6h
		MX 7366	IP44	32	3+E+N	230V	6h
		MX 7367	IP44	32	2+E	400V	6h
LARGE AMP STRAIGHT PLUG		MX 7511	IP67	160	3+E	380-690V	6h
		MX 7512	IP67	160	3+E+N	380-690V	6h
		MX 7513	IP67	200	2+E	380-690V	6h
		MX 7514	IP67	200	3+E	380-690V	6h
		MX 7515	IP67	250	3+E+N	380-690V	6h
		MX 7516	IP67	250	2+E	380-690V	6h
LARGE AMP STRAIGHT PLUG		MX 7517	IP67	300	3+E	380-690V	6h
		MX 7518	IP67	300	3+E+N	380-690V	6h
		MX 7519	IP67	350	2+E	380-690V	6h
		MX 7520	IP67	350	3+E	380-690V	6h
		MX 7521	IP67	400	3+E+N	380-690V	6h
		MX 7522	IP67	400	2+E	380-690V	6h
LARGE AMP SOCKET		MX 7523	IP67	160	3+E	380-690V	6h
		MX 7524	IP67	160	3+E+N	380-690V	6h
		MX 7525	IP67	200	2+E	380-690V	6h
		MX 7526	IP67	200	3+E	380-690V	6h
		MX 7527	IP67	250	3+E+N	380-690V	6h
LARGE AMP CONNECTOR		MX 7528	IP67	250	2+E	380-690V	6h
		MX 7529	IP67	300	3+E	380-690V	6h
		MX 7530	IP67	300	3+E+N	380-690V	6h
		MX 7531	IP67	350	2+E	380-690V	6h
		MX 7532	IP67	350	3+E	380-690V	6h
		MX 7533	IP67	400	3+E+N	380-690V	6h
PANEL SOCKET		MX 7534	IP67	400	2+E	380-690V	6h
		MX 7535	IP67	160	3+E	380-690V	6h
		MX 7536	IP67	160	3+E+N	380-690V	6h
		MX 7537	IP67	200	3+E	380-690V	6h
		MX 7538	IP67	200	3+E+N	380-690V	6h
		MX 7539	IP67	250	3+E	380-690V	6h
		MX 7540	IP67	250	3+E+N	380-690V	6h



# High End Type Industrial Plugs & Sockets

HSN-8536

Description	Product Image	Model No.	IP Protection	Amp	Number of Pole	Voltage	Earthing
PANEL SOCKET		MX 7541	IP67	300	3+E	380-690V	6h
		MX 7542	IP67	300	3+E+N	380-690V	6h
		MX 7543	IP67	350	3+E	380-690V	6h
		MX 7544	IP67	350	3+E+N	380-690V	6h
		MX 7545	IP67	400	3+E	380-690V	6h
		MX 7546	IP67	400	3+E+N	380-690V	6h
PANEL PLUG		MX 7547	IP67	160	3+E	380-690V	6h
		MX 7548	IP67	160	3+E+N	380-690V	6h
		MX 7549	IP67	200	3+E	380-690V	6h
		MX 7550	IP67	200	3+E+N	380-690V	6h
		MX 7551	IP67	250	3+E	380-690V	6h
		MX 7552	IP67	250	3+E+N	380-690V	6h
PANEL PLUG		MX 7553	IP67	300	3+E	380-690V	6h
		MX 7554	IP67	300	3+E+N	380-690V	6h
		MX 7555	IP67	350	3+E	380-690V	6h
		MX 7556	IP67	350	3+E+N	380-690V	6h
		MX 7557	IP67	400	3+E	380-690V	6h
		MX 7558	IP67	400	3+E+N	380-690V	6h
US TYPE CAMLOCK Straight Plug		MX 7559	IP44	200A	Black, Green, Blue, Red, Yellow	600V	
		MX 7560	IP44	400A	Black, Green, Blue, Red, Yellow	600V	
US TYPE CAMLOCK Panel Plug		MX 7561	IP44	200A	Black, Green, Blue, Red, Yellow	600V	
		MX 7562	IP44	400A	Black, Green, Blue, Red, Yellow	600V	



**Product Image**

**Model No.**

**IP Protection**





**Amp**

**Number of Pole**

**Voltage**

**Earthing**

**Description**

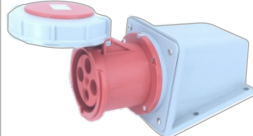
US TYPE CAMLOCK Connector		<b>MX 7563</b>	IP44	200A		Black, Green, Blue, Red, Yellow	600V
		<b>MX 7564</b>	IP44	400A		Black, Green, Blue, Red, Yellow	600V
US TYPE CAMLOCK Panel Socket		<b>MX 7565</b>	IP44	200A		Black, Green, Blue, Red, Yellow	600V
		<b>MX 7566</b>	IP44	400A		Black, Green, Blue, Red, Yellow	600V
T CONNECTOR 1 Outlet + 2 Inlets		<b>MX 7567</b>	IP44	400A		Black, Green, Blue, Red, Yellow	600V
WALL MOUNTED SOCKET		<b>MX 7301E</b>	IP44	16	2+E	230V	6h
		<b>MX 7379E</b>	IP44	16	3+E	400V	6h
		<b>MX 7303E</b>	IP44	16	3+E+N	400V	6h
		<b>MX 7302E</b>	IP44	32	2+E	230V	6h
		<b>MX 7380E</b>	IP44	32	3+E	400V	6h
		<b>MX 7304E</b>	IP44	32	3+E+N	400V	6h
		<b>MX 7381E</b>	IP44	63	2+E	230V	6h
		<b>MX 7382E</b>	IP44	63	3+E	400V	6h
		<b>MX 7305E</b>	IP44	63	3+E+N	400V	6h
WALL MOUNTED SOCKET		<b>MX 7305E</b>	IP67	16	2+E	230V	6h
		<b>MX 7306E</b>	IP67	16	3+E	400V	6h
		<b>MX 7383E</b>	IP67	16	3+E+N	400V	6h
		<b>MX 7307E</b>	IP67	32	2+E	230V	6h
		<b>MX 7384E</b>	IP67	32	3+E	400V	6h
		<b>MX 7385E</b>	IP67	32	3+E+N	400V	6h
		<b>MX 7308E</b>	IP67	63	2+E	230V	6h
		<b>MX 7386E</b>	IP67	63	3+E	400V	6h
		<b>MX 7387E</b>	IP67	63	3+E+N	400V	6h
		<b>MX 7309E</b>	IP67	125	2+E	230V	6h
		<b>MX 7388E</b>	IP67	125	3+E	400V	6h
		<b>MX 7389E</b>	IP67	125	3+E+N	400V	6h

# High End Type Industrial Plugs & Sockets

HSN-8536

Description

Product Image

Model No.	IP Protection	Amp	Number of Pole	Voltage	Earthing
<b>MX 7322E</b>	IP44	16	2+E	230V	6h
<b>MX 7400E</b>	IP44	16	3+E	400V	6h
<b>MX 7324E</b>	IP44	16	3+E+N	400V	6h
<b>MX 7323E</b>	IP44	32	2+E	230V	6h
<b>MX 7401E</b>	IP44	32	3+E	400V	6h
<b>MX 7325E</b>	IP44	32	3+E+N	400V	6h
<b>MX 7402E</b>	IP44	63	2+E	230V	6h
<b>MX 7403E</b>	IP44	63	3+E	400V	6h
<b>MX 7326E</b>	IP44	63	3+E+N	400V	6h
<b>MX 7327E</b>	IP67	16	2+E	230V	6h
<b>MX 7404E</b>	IP67	16	3+E	400V	6h
<b>MX 7405E</b>	IP67	16	3+E+N	400V	6h
<b>MX 7406E</b>	IP67	32	2+E	230V	6h
<b>MX 7407E</b>	IP67	32	3+E	400V	6h
<b>MX 7408E</b>	IP67	32	3+E+N	400V	6h
<b>MX 7409E</b>	IP67	63	2+E	230V	6h
<b>MX 7410E</b>	IP67	63	3+E	400V	6h
<b>MX 7411E</b>	IP67	63	3+E+N	400V	6h
<b>MX 7510E</b>	IP67	125	3+E	400V	6h
<b>MX 7412E</b>	IP44	16	2+E	230V	6h
<b>MX 7413E</b>	IP44	16	3+E	400V	6h
<b>MX 7414E</b>	IP44	16	3+E+N	400V	6h
<b>MX 7415E</b>	IP44	32	2+E	230V	6h
<b>MX 7416E</b>	IP44	32	3+E	400V	6h
<b>MX 7417E</b>	IP44	32	3+E+N	400V	6h
<b>MX 7418E</b>	IP44	63	2+E	230V	6h
<b>MX 7419E</b>	IP44	63	3+E	400V	6h
<b>MX 7420E</b>	IP44	63	3+E+N	400V	6h

PANEL MOUNTED SOCKET STRAIGHT







PANEL MOUNTED SOCKET STRAIGHT



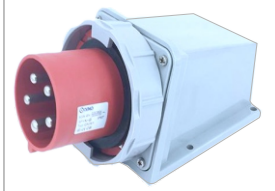

WALL MOUNTED PLUG



Description	Product Image	Model No.	IP Protection	Amp	Number of Pole	Voltage	Earthing
WALL MOUNTED PLUG		MX 7427E	IP67	63	2+E	230V	6h
		MX 7428E	IP67	63	3+E	400V	6h
		MX 7429E	IP67	63	3+E+N	400V	6h
		MX 7430E	IP67	125	2+E	230V	6h
		MX 7431E	IP67	125	3+E	400V	6h
		MX 7432E	IP67	125	3+E+N	400V	6h
PANEL MOUNTED PLUG		MX 7433E	IP44	16	2+E	230V	6h
		MX 7434E	IP44	16	3+E	400V	6h
		MX 7435E	IP44	16	3+E+N	400V	6h
		MX 7436E	IP44	32	2+E	230V	6h
		MX 7437E	IP44	32	3+E	400V	6h
		MX 7438E	IP44	32	3+E+N	400V	6h
		MX 7439E	IP44	63	2+E	230V	6h
		MX 7440E	IP44	63	3+E	400V	6h
PANEL MOUNTED PLUG		MX 7448E	IP67	63	2+E	230V	6h
		MX 7449E	IP67	63	3+E	400V	6h
		MX 7450E	IP67	63	3+E+N	400V	6h
		MX 7451E	IP67	125	2+E	230V	6h
		MX 7452E	IP67	125	3+E	400V	6h
		MX 7453E	IP67	125	3+E+N	400V	6h
PLUG		MX 7328E	IP44	16	2+E	230V	6h
		MX 7328E (BK)	IP44	16	2+E	230V	6h
		MX 7454E	IP44	16	3+E	400V	6h
		MX 7331E	IP44	16	3+E+N	400V	6h
		MX 7329E	IP44	32	2+E	230V	6h
		MX 7455E	IP44	32	3+E	400V	6h
		MX 7332E	IP44	32	3+E+N	400V	6h
		MX 7330E	IP44	63	2+E	230V	6h
		MX 7456E	IP44	63	3+E	400V	6h
MX 7333E	IP44	63	3+E+N	400V	6h		

# High End Type Industrial Plugs & Sockets

Description	Product Image	Model No.	IP Protection	Amp	Number of Pole	Voltage	Earthing
PLUG		MX 7334E	IP67	16	2+E	230V	6h
		MX 7457E	IP67	16	3+E	400V	6h
		MX 7336E	IP67	16	3+E+N	400V	6h
		MX 7335E	IP67	32	2+E	230V	6h
		MX 7458E	IP67	32	3+E	400V	6h
		MX 7337E	IP67	32	3+E+N	400V	6h
		MX 7459E	IP67	63	2+E	230V	6h
		MX 7460E	IP67	63	3+E	400V	6h
		MX 7338E	IP67	63	3+E+N	400V	6h
		MX 7461E	IP67	125	2+E	230V	6h
		MX 7462E	IP67	125	3+E	400V	6h
		MX 7339E	IP67	125	3+E+N	400V	6h
		CONNECTOR		MX 7340E	IP44	16	2+E
MX 7463E	IP44			16	3+E	400V	6h
MX 7342E	IP44			16	3+E+N	400V	6h
MX 7341E	IP44			32	2+E	230V	6h
MX 7464E	IP44			32	3+E	400V	6h
MX 7343E	IP44			32	3+E+N	400V	6h
MX 7465E	IP44			63	2+E	230V	6h
MX 7466E	IP44			63	3+E	400V	6h
MX 7344E	IP44			63	3+E+N	400V	6h
CONNECTOR		MX 7467E	IP67	16	2+E	230V	6h
		MX 7468E	IP67	16	3+E	400V	6h
		MX 7345E	IP67	16	3+E+N	400V	6h
		MX 7469E	IP67	32	2+E	230V	6h
		MX 7470E	IP67	32	3+E	400V	6h
		MX 7346E	IP67	32	3+E+N	400V	6h
		MX 7471E	IP67	63	2+E	230V	6h
		MX 7472E	IP67	63	3+E	400V	6h
		MX 7347E	IP67	63	3+E+N	400V	6h
		MX 7473E	IP67	125	2+E	230V	6h
		MX 7474E	IP67	125	3+E	400V	6h
		MX 7348E	IP67	125	3+E+N	400V	6h



Description

Product Image

Model No.

IP Protection

Amp

Number of Pole

Voltage

Earthing

MULTIPLE MULTI-FUNCTION SOCKET



MX 7568E

IP44

16

2+E

230V

3Way

MX 7569E

IP44

32

3+E+N

400V

3Way



MX 7570E

IP67

16

2+E

230V

2Way



# Smart-Intelligent Power Distribution Unit (PDU)



Intelligent data acquisition



Remote monitoring management



Supports IP filtering



Multiple alarm methods



Supports cascading



Wide voltage platform

- Real-time monitoring and control for optimized uptime.
- Energy-efficient design to reduce operational costs.
- Scalable solutions that adapt to growing IT infrastructure.
- Advanced safety features with overload and surge protection.
- Centralized access for secure and seamless data center management.
- Customizable configurations including C13, C14, C19, C20, Universal, Indian, UK, Schuko, USA sockets, and more

## MX 4262

- Wide voltage input: 150–433V / 110–250V, Output: 100–260V
- Current capacity: 16–400A (single/three-phase)
- Interfaces: USB, RS232, RS485, Network, Buzzer indicators
- Self-wiring junction box with intelligent monitor module
- Customizable output module with color-coded outlets
- Supports cascading Upto 7 Modules (42 Sockets)

## MX 4263

- Wide voltage input: 150–433V / 110–250V, Output: 100–260V
- Current capacity: 16–400A (single/three-phase)
- Interfaces: USB, RS485, Network, Sensor ports (1–4), Dry node outputs (1–2)
- Modular customizable design

MX 4263

MX 4262



IEC C13



IEC C14



IEC C19



IEC C20



INDIAN SOCKET



INDIAN SOCKET



UNIVERSAL SOCKET

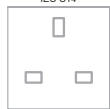

UK SOCKET

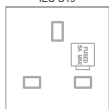

UK SOCKET WITH FUSE & SHUTTER

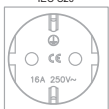

GERMAN SCHUKO SOCKET

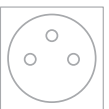

FRENCH SOCKET



USA SOCKET

# Grateful For The Following Brands For Their Trust

 <b>Reliance</b>	<b>PHILIPS</b>	
 <i>Unilever</i>	<b>Walmart</b> 	
 <b>HSBC</b>	<b>KONE</b>	 <b>Pidilite</b>
<b>TATA</b>	 <b>Kokilaben Dhirubhai Ambani Hospital &amp; medical research Institute</b>	<b>Infosys</b>
<b>McKinsey &amp; Company</b>	<b>IIT</b>  <small>INSTITUTION FOR INTEGRATED TECHNOLOGY MANAGEMENT</small>	 <b>cognizant</b>
 <b>IndianOil</b>	<b>TAJ</b> 	<b>L'ORÉAL</b>
<b>AIRBUS</b>	 <b>BHEL</b>	 <b>Bombay Dyeing</b> <small>RED   BATH   COORDINATES</small>
 <b>AVIENT</b>	 <b>इसरो ISRO</b>	
 <b>GRIL</b> <b>GR Infraprojects Ltd.</b>	 <b>MAYFAIR</b> <i>Hotels &amp; Resorts</i>	 <b>ideaForge</b> <small>Create. Inspire</small>
 <b>99Games</b>	 <b>Sapient</b> <small>Creating Happy Investors</small>	
 <b>Prestige</b> <small>UNIVERSITY</small>	<b>SCAME</b>	<b>Rustomjee</b>
 <b>BHIVE</b> <b>WORKSPACE</b>	 <b>signify</b>	



CONNECTING THE FUTURE

**MX MDR TECHNOLOGIES LTD.**

EXPERIENCE CENTER :

Unit No.5/K, Laxmi Industrial Estate, New Link Road, Andheri (W),  
Mumbai-400053, INDIA

FACTORY :

Plot No.101, Sector1 Gaurapada, Vasai (E), Dist. Palghar-401208. INDIA

☎ +91 98922 50949 ✉ info@mdrelectronics.com

[www.mdrelectronics.com](http://www.mdrelectronics.com)

